



## THE 37TH ORDINARY GENERAL MEETING OF SHAREHOLDERS

# NOTICE OF CONVOCATION

[Request to Refrain from Attending in Person]

To prevent the spread of novel coronavirus disease (COVID-19), please exercise your voting rights via the Internet or in writing. **We strongly request that you refrain from attending the meeting in person.**

Please check the website below for details regarding measures being taken at the Ordinary General Meeting of Shareholders to prevent the spread of COVID-19.

<https://group.ntt/en/ir/37sokai/>

**\* Souvenirs will not be presented.**

# Table of contents

■ Notice of Convocation of the 37th Ordinary General Meeting of Shareholders .....	1
■ Exercising Your Voting Rights .....	3
■ Reference Materials for the Ordinary General Meeting of Shareholders	
First Item: Distribution of Earned Surplus .....	5
Second Item: Amendment to the Articles of Incorporation .....	6
Third Item: Election of Ten (10) Members of the Board .....	9
Fourth Item: Election of Two (2) Audit & Supervisory Board Members .....	17
» Attachments	
■ Business Report	
I Outline of the Business of NTT Group .....	23
II Matters Regarding Shares .....	43
III Matters Regarding Corporate Governance .....	44
IV Matters Regarding Corporate Officers .....	51
■ Consolidated Financial Statements	
Consolidated Statement of Financial Position .....	57
Consolidated Statement of Profit or Loss .....	58
■ Non-consolidated Financial Statements	
Non-consolidated Balance Sheet .....	59
Non-consolidated Statement of Income .....	60
■ Auditor's Reports	
Auditor's Report on Consolidated Financial Statements .....	61
Auditor's Report on Non-consolidated Financial Statements .....	63
Audit & Supervisory Board's Report .....	65

Based on the applicable laws and regulations, and Article 16 of the Articles of Incorporation, the following items are posted on NTT's website and are therefore not included in the Attachments to the Notice of Convocation.

## Business Report

- Outline of the Business of NTT Group
  - Main Businesses
  - Main Locations, etc.
  - Employment
  - Changes in Consolidated Assets and Consolidated Profit or Loss of NTT Group
  - Changes in Non-consolidated Assets and Non-consolidated Income of NTT
- Matters Regarding Corporate Officers
  - Agreements Limiting Liability
- Matters Regarding Independent Auditors
- Content of Resolutions Concerning the Development of Systems to Ensure the Propriety of NTT's Business
- Outline of Operations of the Systems to Ensure the Propriety of NTT's Business

## Consolidated Financial Statements

- Consolidated Statement of Changes in Equity
- Notes to Consolidated Financial Statements

## Non-consolidated Financial Statements

- Non-consolidated Statement of Changes in Shareholders' Equity and Other Net Assets
- Notes to Non-consolidated Financial Statements



NTT Website

<https://group.ntt/en/ir/>

- The Business Report, audited by Audit & Supervisory Board Members, and the Consolidated Financial Statements and the Non-consolidated Financial Statements, audited by independent auditors and Audit & Supervisory Board Members, are the documents presented in the Attachments to the Notice of Convocation of the 37th Ordinary General Meeting of Shareholders as well as items posted on our website (excluding "(Reference)").
- Any subsequent revisions to the reference materials for the Ordinary General Meeting of Shareholders or the Business Report, Consolidated Financial Statements or Non-consolidated Financial Statements will be posted on our website.

# You can exercise your voting rights or view the convocation notice via your smartphone.

## • You may use a voting rights exercising service for smartphones.

By using your smartphone to scan the QR code® on the voting rights exercise form, you can log in to the designated website and exercise the voting rights without entering your voting code and password.

### Image for use

#### STEP 1

Use your smartphone or tablet device to scan the “QR code for login to the voting rights exercising website for smartphones” located in the bottom-right of the enclosed voting rights exercise form.

You **do not need** to enter your voting code or password



#### STEP 2

Access the URL shown on the screen to open the voting rights exercising website. Two methods for exercising voting rights are available.

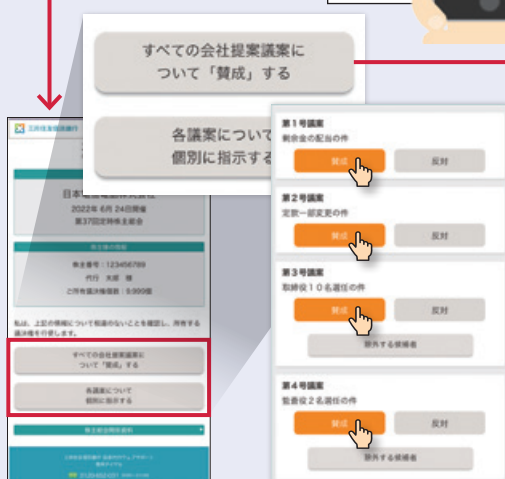

#### STEP 3

When the confirmation screen appears, check there is no problem with your selected vote and click “exercise this content” button to finish your exercise!

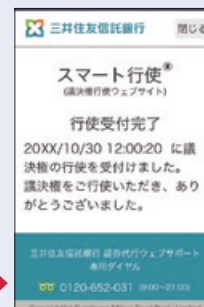

\*QR code is a trademark of DENSO WAVE INCORPORATED.

## • You can view major contents of the convocation notice via your smartphone.



<https://p.sokai.jp/9432/>



# Notice of Convocation of the 37th Ordinary General Meeting of Shareholders

## To All Shareholders

I would like to take this opportunity to thank all of NTT's shareholders for your continued support. Allow me to begin by extending our heartfelt thoughts and prayers to everyone who has been impacted by the COVID-19 pandemic.

During the 37th fiscal year (April 1, 2021 to March 31, 2022), we refined the NTT Group Medium-Term Management Strategy, and as the directionality of the Group's transformation, we focused on a new management style that responds to a distributed network society, strengthening of domestic/global businesses, and enhancement of corporate value through ESG initiatives, setting forth and implementing a variety of measures. We also reviewed our existing CSR Charter and established the global-level Sustainability Charter that encompasses SDGs, ESG, and CSV as a broader concept. We will continue to contribute to the realization of a sustainable society through the transformation of NTT Group.

The 37th Ordinary General Meeting of Shareholders will be held on Friday, June 24, 2022. I would like to ask our shareholders to exercise their voting rights via the Internet or in writing, and conclude this message by thanking our shareholders in advance for their continued understanding and support.



Jun Sawada  
President and Chief Executive Officer  
Representative Member of the Board  
NIPPON TELEGRAPH AND TELEPHONE CORPORATION

澤田 純

<b>1</b>	<b>Date and Time:</b>	Friday, June 24, 2022 10:00 a.m. (JST)
<b>2</b>	<b>Venue:</b>	Grand Prince Hotel Shin Takanawa 13-1, Takanawa 3-chome, Minato-ku, Tokyo
<b>3</b>	<b>Purpose of the Meeting:</b>	<p><b>Matters to be reported</b></p> <p>1 Report on the Business Report, Consolidated Financial Statements and audit results of independent auditors and Audit &amp; Supervisory Board for the 37th fiscal year (from April 1, 2021 to March 31, 2022)</p> <p>2 Report on the Non-consolidated Financial Statements for the 37th fiscal year (from April 1, 2021 to March 31, 2022)</p> <hr/> <p><b>Matters to be resolved</b></p> <p><b>First Item</b> Distribution of Earned Surplus</p> <p><b>Second Item</b> Amendment to the Articles of Incorporation</p> <p><b>Third Item</b> Election of Ten (10) Members of the Board</p> <p><b>Fourth Item</b> Election of Two (2) Audit &amp; Supervisory Board Members</p>

1. The ordinary general meeting of shareholders is a valuable opportunity to have a dialogue with shareholders once a year. However, in view of the spread of COVID-19 infection, **we strongly request that you refrain from attending the meeting.**
  2. We request that you exercise your voting rights prior to the meeting via the Internet or in writing. For details, please read Exercising Your Voting Rights on page 3 of this Notice of Convocation. The deadline for exercising voting rights is **at 5.30 p.m. on Thursday, June 23, 2022 (JST).**
  3. You will be able to view the meeting on the day through a real-time stream\* over the Internet.
  4. The Company will receive questions\* prior to the meeting through the Internet and other means.
- \* For details regarding the real-time stream over the Internet and reception of questions in advance, please read the guide included on the back cover of this Notice of Convocation.
5. **Souvenirs will not be presented.**

# Exercising Your Voting Rights

You are requested to review the attached Reference Materials for the Ordinary General Meeting of Shareholders (pages 5 - 20) before exercising your voting rights. Shareholders may exercise their voting rights in the following ways.



## A Voting via the Internet\*

**INTERNET DEADLINE**  
**Thursday, June 23, 2022**  
**5:30 p.m. (JST)**

### "Smart Vote®" method

1 By scanning the QR code located on the bottom right of the voting rights exercise form, you can simply exercise your voting rights without entering your voting code and password.



**Caution**

If you need to make a correction to the content of your vote after you have exercised your voting rights, please log in by entering your voting code and password for the PC site to make the correction.

2 Please input "For" or "Against" following the instructions displayed on the screen.

Please refer to the page following the table of contents for the optional methods for exercising your voting rights



### "Voting Code/Password Input" method

1 Exercise your voting rights via the Internet by accessing the designated web site for shareholder voting (<https://www.web54.net>) from any one of PCs, smartphones and mobile phones.



2 Please enter the "Voting Code" given on the voting rights exercise form.

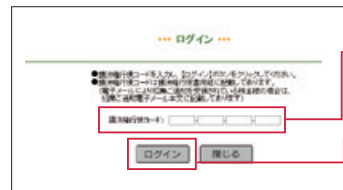

Enter the "Voting Code"  
 Click the "Login"

3 Please enter the "Password" given on the voting rights exercise form.

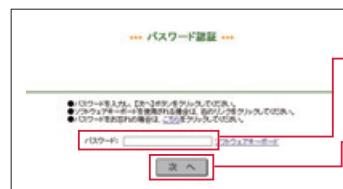

Enter the "Password"  
 Click the "Next"

4 Next, indicate your approval or disapproval of the resolutions by following the instructions on the screen.

If you have questions about the use of a PC, smartphone or mobile phone for exercising your vote via the Internet, please contact:

Sumitomo Mitsui Trust, Securities Agent  
 Web Support Hotline  
**0120-652-031** (Toll Free)  
 (9:00 to 21:00)

\* Institutional investors can utilize the electronic voting platform operated by ICJ, Inc.

\*QR code is a trademark of DENSO WAVE INCORPORATED.

## B Voting via mail

**MAIL DEADLINE**  
**Thursday, June 23, 2022**  
**5:30 p.m. (JST)**



Please indicate your approval or disapproval of the resolutions on the enclosed voting rights exercise form and return it to the Company by mail so that it arrives before the deadline.

### How to fill out your voting rights exercise form

→ Please indicate your approval or disapproval of resolution here.

#### First and Second Items:

- If you approve, put a circle in the box marked 賛 [Approve].
- If you disapprove, put a circle in the box marked 否 [Disapprove].

#### Third and Fourth Items:

- If you approve all candidates, put a circle in the box marked 賛 [Approve].
- If you disapprove all candidates, put a circle in the box marked 否 [Disapprove].
- If you disapprove certain candidates, put a circle in the box marked 賛 [Approve] and write the number of the candidate(s) you wish to disapprove.

**You will need the "QR code" given on the enclosed voting rights exercise form in order to vote via the Internet.**

- Duplicate voting via mail or online will be handled as follows:
  - In the case of duplicate voting online, the last vote placed will be considered valid.
  - In the case of duplicate voting via mail, the votes on the last voting rights exercise form received will be considered valid.
  - In the case of duplicate voting done via both online and mail, the vote received last will be considered valid. If both votes are received on the same day, the votes placed online will be considered valid.
- If no approval or disapproval is expressed for the respective proposals, it will be treated as an approval vote.
- If you wish to make a diverse exercise of your voting rights, please advise us in writing three days prior to the Ordinary General Meeting of Shareholders, stating your reasons therefor.
- In view of the spread of COVID-19 infection, we urge you to refrain from attending the meeting in person, and to exercise your voting rights prior to the meeting via the Internet or in writing. In order to reduce the risk of infection, the venue of the Ordinary General Meeting of Shareholders will have approximately 500 seats with sufficient space between each seat, and therefore, you may be refused entrance even if you do travel to the venue in person.

END

# Reference Materials for the Ordinary General Meeting of Shareholders

## Resolutions and matters for reference

### First Item Distribution of Earned Surplus

Nippon Telegraph and Telephone Corporation (the "Company") has set as its important management challenge the maximization of corporate value over the medium to long term, and the Company has identified the return of profits to shareholders as an important management goal.

In determining the level of dividends for the fiscal year ended March 31, 2022, the Company, while giving consideration to stability and sustainability, takes into account a full range of factors, including business performance, financial standing and dividend payout ratio.

<b>1 Type of asset to be distributed:</b>	Cash
<b>2 Matters relating to allotment of dividends and total amount of dividends to be distributed:</b>	Per share of common stock : ¥60 Total amount of dividends : ¥212,551,333,560

As the Company has already distributed an interim dividend of ¥55 per share of common stock, the annual dividend for the fiscal year will be ¥115 per one share of common stock.

<b>3 Date on which the dividend becomes effective:</b>	June 27, 2022
--	---------------

#### Changes in Dividends per Share

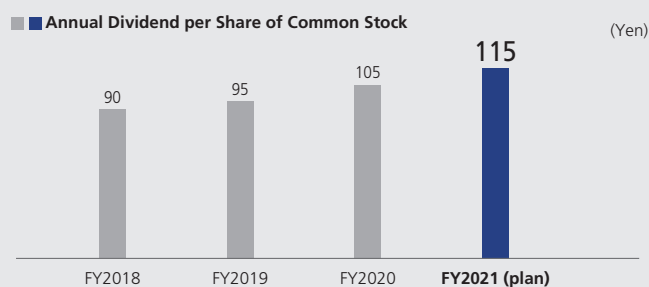

Note: NTT implemented a two-for-one stock split of common stock with an effective date of January 1, 2020. Figures for annual dividend per share of common stock are stated, taking the stock split into consideration.

Please refer to page 50 for the capital policy. ▶



## Second Item Amendment to Articles of Incorporation

### 1. Reasons for the Amendments

#### (1) Item regarding electronic provision of information materials for the General Meeting of Shareholders

Since the revised provisions provided for in the proviso to Article 1 of the Supplementary Provisions of the Act Partially Amending the Companies Act (Act No. 70 of 2019) are to be enforced on September 1, 2022, a system for provision of information materials for the General Meeting of Shareholders in electronic format is to be introduced. Accordingly, the Company proposes to make the following changes to its Articles of Incorporation.

- (i) Article 16 (Measures, etc. for Providing Information in Electronic Format), paragraph 1 in the proposed amendments will be newly established to stipulate that the Company shall take measures for providing information that constitutes the content of reference documents for the General Meeting of Shareholders, etc. in electronic format.
- (ii) Article 16 (Measures, etc. for Providing Information in Electronic Format), paragraph 2 in the proposed amendments will be newly established to enable limiting of the scope of the items to be stated in paper-based documents delivered to shareholders who requested the delivery of paper-based documents, among the items of information that constitutes the content of reference documents for the General Meeting of Shareholders, etc. to be provided in electronic format, to the scope stipulated by the regulations of Ministry of Justice.
- (iii) Since the provisions for Article 16 (Disclosure over the Internet and Deemed Delivery of Reference Documents concerning the Exercise of Voting Rights, etc.) of the current Articles of Incorporation will no longer be required after the introduction of the system for provision of information materials for the General Meeting of Shareholders in electronic format, they will be deleted.
- (iv) Supplementary provisions will be provided regarding the effective date, etc. of the aforementioned establishment and deletion of provisions. These supplementary provisions will be deleted after their expiration date.

#### (2) Item regarding the holding of the General Meeting of Shareholders without a designated location

Following the enforcement of the Act Partially Amending the Industrial Competitiveness Enhancement Act and Other Related Laws and Regulations (Act No. 70 of 2021), listed companies that have received confirmation from the Minister of Economy, Trade and Industry and the Minister of Justice may now hold general meetings of shareholders without designating a location (so called "virtual-only general meeting of shareholders") by stipulating it in their Articles of Incorporation. Therefore, to enable the General Meeting of Shareholders to be held without designating a location in cases where the Board of Directors deems it inappropriate to hold the General Meeting of Shareholders at a designated location due to an outbreak of infectious disease or a natural disaster, etc., the Articles of Incorporation will be amended in the necessary places (Article 14 in the proposed amendments).

On April 19, 2022, the Company received the confirmation, which is necessary for these amendments (Article 14 in the proposed amendments), from the Minister of Economy, Trade and Industry and the Minister of Justice pursuant to Article 66-1 of the Act on Strengthening Industrial Competitiveness (Act No. 98 of 2013).

#### (3) Item regarding the number of Audit & Supervisory Board Members

Under the current Articles of Incorporation, the number of Audit & Supervisory Board Members is limited to five. To further enhance and strengthen the audit system, the necessary changes will be made to increase the number of Audit & Supervisory Board Members by one to a limit of six (Article 27 in the proposed amendments).

## 2. Content of the Amendments

The content of the amendments is as follows:

<Comparison table of current and proposed Articles of Incorporation>

(Underlined sections indicate proposed amendments)

Current Articles of Incorporation	Proposed Amendments
<p>(Convocation) Article 14</p> <ol style="list-style-type: none"> <li>1. (Omitted)</li> <li>2. (Omitted)</li> </ol> <p>(Newly established)</p>	<p>(Convocation) Article 14</p> <ol style="list-style-type: none"> <li>1. (Same as current)</li> <li>2. (Same as current)</li> <li>3. <u>The Company may hold a general meeting of Shareholders without a designated location if the Board of Directors determines that it is not appropriate to hold a General Meeting of Shareholders at a designated location due to the outbreak of infectious disease or a natural disaster, etc.</u></li> </ol>
<p><u>(Disclosure over the Internet and Deemed Delivery of Reference Documents concerning the Exercise of Voting Rights, etc.)</u> Article 16</p> <p><u>When convening a general meeting of Shareholders, the Company shall, when disclosing information related to matters which must be described or otherwise expressed in reference documents concerning the exercise of voting rights, business reports, financial statements and consolidated financial statements, by use of internet methods in accordance with the regulations of the Ministry of Justice, be entitled to deem the same to have been delivered to Shareholders.</u></p>	<p>(Deleted)</p>
<p>(Newly established)</p>	<p><u>(Measures, etc. for Providing Information in Electronic Format)</u> Article 16</p> <ol style="list-style-type: none"> <li>1. <u>When convening a general meeting of Shareholders, the Company shall take measures for providing information that constitutes the content of reference documents for the general meeting of Shareholders, etc. in electronic format.</u></li> <li>2. <u>Among items for which the measures for providing information in electronic format will be taken, the Company may exclude all or some of those items designated by the regulations of Ministry of Justice from statements in the paper-based documents to be delivered to shareholders who requested the delivery of paper-based documents by the record date of voting rights.</u></li> </ol>

Current Articles of Incorporation	Proposed Amendments
<p><b>(Number of Audit &amp; Supervisory Board Members)</b> Article 27 There shall be no more than <u>five (5)</u> Audit &amp; Supervisory Board Members of the Company.</p>	<p><b>(Number of Audit &amp; Supervisory Board Members)</b> Article 27 There shall be no more than <u>six (6)</u> Audit &amp; Supervisory Board Members of the Company.</p>
<p>(Newly established)</p>	<p><b>(Supplementary Provisions)</b></p> <ol style="list-style-type: none"> <li>1. <u>The amendment to the Articles of Incorporation pertaining to Article 16 shall be effective from September 1, 2022, which is the date of enforcement of the revised provisions provided for in the proviso to Article 1 of the Supplementary Provisions of the Act Partially Amending the Companies Act (Act No. 70 of 2019) (hereinafter referred to as the "Date of Enforcement").</u></li> <li>2. <u>Notwithstanding the provision of the preceding paragraph, Article 16 of the pre-amended Articles of Incorporation (Disclosure over the Internet and Deemed Delivery of Reference Documents concerning the Exercise of Voting Rights, etc.) shall remain effective regarding any general meeting of shareholders held on a date within six (6) months from the Date of Enforcement.</u></li> <li>3. <u>These Supplementary Provisions shall be deleted on the date when six (6) months have elapsed from the Date of Enforcement or three (3) months have elapsed from the date of the general meeting of shareholders in the preceding paragraph, whichever is later.</u></li> </ol>

## Third Item Election of Ten (10) Members of the Board

The term of office of all eight current Members of the Board will expire at the conclusion of this Ordinary General Meeting of Shareholders.

The Company proposes the election of ten Members of the Board with the aim of further invigorating strategic discussions on the Board itself.

The candidates for Members of the Board are as follows:

### 1 Jun Sawada

(July 30, 1955)

Reelection

Number of shares of the Company held:  
41,500 shares



Years served as Member of the Board  
8 years

Number of Board of Directors Meetings attended (Percent)  
15/15 (100%)

#### Career summary, position, responsibilities and description of significant concurrent positions

April 1978:	Joined Nippon Telegraph and Telephone Public Corporation
June 2008:	Senior Vice President Executive Manager of the Corporate Strategy Planning Department Member of the Board of NTT Communications Corporation
June 2011:	Executive Vice President Executive Manager of the Corporate Strategy Planning Department Member of the Board of NTT Communications Corporation
June 2012:	Senior Executive Vice President Executive Manager of the Corporate Strategy Planning Department Member of the Board of NTT Communications Corporation
June 2013:	Senior Executive Vice President Member of the Board of NTT Communications Corporation
June 2014:	Senior Executive Vice President Member of the Board of the Company
June 2016:	Director and President, Chief Executive Officer of NTT Security Corporation
June 2018:	President and Chief Executive Officer Member of the Board of the Company
August 2018:	President and Chief Executive Officer Member of the Board of NTT, Inc. (present post)
June 2020:	President and Chief Executive Officer Representative Member of the Board of the Company (present post)

#### Reasons for Reelection as a Member of the Board

Mr. Jun Sawada has a wealth of experience as a senior corporate manager in the Company as represented by his role in formulating and implementing NTT Group's medium-term management strategies, his work to boost competitiveness and profitability in domestic businesses, and his efforts to expand overseas businesses.

The Company also believes him to have a high level of integrity and insight.

## 2 Akira Shimada

(December 18, 1957)

Reelection

Number of shares of the Company held:  
26,808 shares



Years served as Member of the Board

10 years

Number of Board of Directors Meetings attended (Percent)

15/15 (100%)

### Career summary, position, responsibilities and description of significant concurrent positions

April 1981:	Joined Nippon Telegraph and Telephone Public Corporation
June 2007:	Vice President of Corporate Strategy Planning of the Company
July 2007:	General Manager of the Accounts and Finance Department of Nippon Telegraph and Telephone West Corporation
July 2009:	General Manager of the General Affairs and Personnel Department of Nippon Telegraph and Telephone East Corporation
June 2011:	Senior Vice President General Manager of the General Affairs and Personnel Department Member of the Board of Nippon Telegraph and Telephone East Corporation
June 2012:	Senior Vice President Head of General Affairs Member of the Board of the Company
June 2012:	Member of the Board of Nippon Telegraph and Telephone West Corporation
June 2015:	Executive Vice President Head of General Affairs Member of the Board of the Company
June 2018:	Senior Executive Vice President Member of the Board of the Company
August 2018:	Member of the Board of NTT, Inc.
October 2018:	Senior Executive Vice President of NTT, Inc. (present post)
June 2020:	Senior Executive Vice President Representative Member of the Board of the Company (present post)

### Reasons for Reelection as a Member of the Board

Mr. Akira Shimada has a wealth of experience as a senior corporate manager in the Company as represented by his role in implementing medium-term management strategies as the person responsible for overall business strategy and finance, and engaging in business operations relating to human resources and legal affairs of the entire NTT Group.

The Company also believes him to have a high level of integrity and insight.

## 3 Katsuhiko Kawazoe

(September 5, 1961)

New election

Number of shares of the Company held:  
13,300 shares



Total number of years including the number of years in office as a Member of the Board in the past

2 years

### Career summary, position, responsibilities and description of significant concurrent positions

April 1987:	Joined the Company
August 2003:	Senior Research Engineer of the Cyberspace Laboratories of the Cyber Communications Laboratory Group of the Company
October 2007:	Senior Research Engineer of the Cyber Solutions Laboratories of the Cyber Communications Laboratory Group of the Company
July 2008:	Vice President of Research and Development Planning of the Company
July 2014:	Head of the Service Evolution Laboratories of the Service Innovation Laboratory Group of the Company
July 2016:	Head of the Service Innovation Laboratory Group of the Company
June 2018:	Senior Vice President Head of Research and Development Planning Member of the Board of the Company
June 2020:	Executive Vice President Head of Research and Development Planning of the Company (present post)

### Reasons for Election as a Member of the Board

Mr. Katsuhiko Kawazoe has a wealth of experience in business execution, including involvement in the work of formulating and promoting the research and development strategy in the Company.

The Company also believes him to have a high level of integrity and insight.

## 4 Takashi Hiroi

(February 13, 1963)

New election

Number of shares of the Company held:  
12,000 shares



Total number of years including the number of years in office as a Member of the Board in the past  
5 years

### Career summary, position, responsibilities and description of significant concurrent positions

April 1986: Joined the Company  
May 2005: Vice President of Corporate Business Strategy of the Company  
June 2008: Vice President of Strategic Business Development of the Company  
July 2009: Vice President of Corporate Strategy Planning of the Company  
June 2014: Head of Finance and Accounting of the Company  
June 2015: Senior Vice President  
Head of Finance and Accounting  
Member of the Board of the Company  
June 2020: Executive Vice President  
General Manager of Accounts and Finance Department  
Member of the Board of Directors of NTT DOCOMO, INC.  
December 2020: Senior Executive Vice President  
Representative Member of the Board of Directors of NTT DOCOMO, INC.  
(scheduled to retire on June 21, 2022)

### Reasons for Election as a Member of the Board

Mr. Takashi Hiroi has a wealth of experience as a manager and the person responsible for overall business strategy and finance at a Group company and the Company.  
The Company also believes him to have a high level of integrity and insight.

## 5 Akiko Kudo

(July 4, 1967)

New election

Number of shares of the Company held:  
2,900 shares



### Career summary, position, responsibilities and description of significant concurrent positions

April 1990: Joined the Company  
June 2014: Head of Public Relations of Corporate Planning of NTT Communications Corporation  
July 2016: Director of Tokai Branch of West Japan Sales Division of NTT Communications Corporation  
June 2019: Senior Vice President  
Head of Fifth Sales Division of NTT Communications Corporation  
April 2020: Deputy Senior Vice President of Fourth Business Solutions of Business Solution Division of NTT Communications Corporation  
June 2020: Senior Vice President  
Head of Public Relations  
Deputy Head of Business Strategy of the Company (present post)

### Reasons for Election as a Member of the Board

Ms. Akiko Kudo has a wealth of experience related to business execution, including involvement in the work of formulating and promoting strategy for public relations and new business creation at the Company.  
The Company also believes her to have a high level of integrity and insight.

## 6 Ken Sakamura

(July 25, 1951)

Reelection

Outside

Independent

Number of shares of the Company held:  
1,700 shares



Years served as Member of the Board

3 years

Number of Board of Directors Meetings attended (Percent)

15/15 (100%)

### Career summary, position, responsibilities and description of significant concurrent positions

April 2000:	Professor of the Interfaculty Initiative in Information Studies and the Graduate School of Interdisciplinary Information Studies of the University of Tokyo
January 2002:	Director of YRP Ubiquitous Networking Laboratory (present post)
April 2009:	Director of Institute of Infrastructure Application of Ubiquitous Computing of the Interfaculty Initiative in Information Studies of the University of Tokyo
October 2014:	President of Vitalizing Local Economy Organization by Open Data & Big Data (present post)
April 2017:	Professor and Dean of Faculty of Information Networking for Innovation and Design of Toyo University Head of collaboration Hub for University and Business of Toyo University (present post)
June 2017:	Emeritus Professor of the University of Tokyo (present post)
June 2019:	Member of the Board of the Company (present post)
August 2019:	President of Association for IoT Services Coordination (present post)

### Reasons for Reelection as an Outside Member of the Board and Overview of Expected Roles

Mr. Ken Sakamura has a wealth of experience as an operational director of research institutions, including universities, and has a high level of integrity and insight. The Company therefore believes that he will help strengthen the supervisory function for business execution and expects to incorporate the advice he provides from his wide-ranging perspective.

### Matters regarding independence

Although the Company and its major subsidiaries have relationships involving transactions and donations with the University of Tokyo, where Mr. Ken Sakamura previously served as a professor, and Toyo University, where he currently serves as a dean, as shown in the table below, both cases fulfill the independence criteria stipulated by the Tokyo Stock Exchange, on which the Company is listed, and the Company's own independence standards for independent officers.\*

Transaction counterparty	Content	Comparison basis	Comparative size
The University of Tokyo, where Mr. Ken Sakamura previously served as a professor	Total annual amount of transactions	Total annual operating revenues of the Company and its major subsidiaries	Less than 1%
		Total annual income of the university	Less than 1%
	Total annual amount of donations	Total annual income of the university	Less than 1%
Toyo University, where Mr. Ken Sakamura currently serves as a dean	Total annual amount of transactions	Total annual operating revenues of the Company and its major subsidiaries	Less than 1%
		Total annual income of the university	Less than 1%
	Total annual amount of donations	—	Less than ¥10 million annually

\* Please refer to page 49 for details on the Company's independence standards for independent officers.

Notes: 1. Mr. Ken Sakamura is a candidate for outside Member of the Board.

Mr. Ken Sakamura has not previously been involved in the management of a company other than by way of becoming an outside member of the board or an outside audit & supervisory board member. However, as stated in the above reasons for election as an outside Member of the Board, the Company has determined that he is capable of adequately serving as an outside Member of the Board.

In addition, as stated in the above matters regarding independence, as Mr. Ken Sakamura fulfills the independence criteria stipulated by the Tokyo Stock Exchange, on which the Company is listed, and the Company's own independence standards for independent officers, and there is no concern that conflicts of interest with general shareholders would arise, the Company has designated him as an independent officer and filed the information related thereto with the aforementioned stock exchange. The Company plans to continue to designate Mr. Ken Sakamura as an independent officer should his election be approved.

- In order for Mr. Ken Sakamura to fully perform his expected role as an outside Member of the Board, pursuant to the provisions of Article 427, paragraph (1) of the Companies Act, the Company has entered into agreement with the candidate limiting his liability for damages pursuant to Article 423, paragraph (1) of the same act. The maximum amount of liability for damages pursuant to such agreement is the minimum liability amount stipulated in Article 425, paragraph (1) of the Companies Act. In the event that the appointment of Mr. Ken Sakamura is approved, the Company intends to continue the said agreement with him.



### Career summary, position, responsibilities and description of significant concurrent positions

July 1971:	Joined IBM Japan, Ltd.
April 2004:	Director and Senior Executive Officer of IBM Japan, Ltd.
April 2007:	Technical Advisor of IBM Japan, Ltd. (retired on March 31, 2008)
April 2007:	Board Chair of Japan Women's Innovative Network (present post)
April 2008:	Representative Director, Chairman of the Board, President & CEO of Berlitz Corporation
June 2008:	Director of Sony Corporation (retired on June 19, 2014)
October 2009:	Director and Executive Vice President of Benesse Holdings, Inc. (retired on June 22, 2013)
April 2013:	Honorary Chairman of Berlitz Corporation (retired on June 22, 2013)
May 2013:	Director of AEON Co., Ltd. (retired on May 22, 2020)
June 2013:	Director (Chairperson of the Audit Committee) of HOYA CORPORATION (present post)
September 2013:	President and CEO of Globalization Research Institute Co., Ltd. (present post)
March 2014:	Director of DIC Corporation (retired on March 27, 2019)
June 2018:	Director of Teijin Limited
	Member of the Advisory Board of Teijin Limited (present post)
June 2021:	Director of SINTOKOGIO, LTD. (present post)

### Reasons for Election as an Outside Member of the Board and Overview of Expected Roles

Ms. Yukako Uchinaga has a wealth of experience in global corporate management and diversity promotion, and has a high level of integrity and insight. The Company therefore believes that she will help strengthen the supervisory function for business execution and expects to incorporate the advice she provides from her wide-ranging perspective on management.

### Matters regarding independence

Although the Company and its major subsidiaries have relationships involving transactions with IBM Japan Ltd., where Ms. Yukako Uchinaga previously served as Director and Senior Executive Officer, Berlitz Corporation, where she previously served as Representative Director, Chairman of the Board, President & CEO, Benesse Holdings, Inc., where she previously served as Director and Executive Vice President, and Globalization Research Institute Co., Ltd., where she currently serves as President and CEO, as shown in the table below, all cases fulfill the independence criteria stipulated by the Tokyo Stock Exchange, on which the Company is listed, and the Company's own independence standards for independent officers.\*

Transaction counterparty	Content	Comparison basis	Comparative size
IBM Japan Ltd., where Ms. Yukako Uchinaga previously served as Director and Senior Executive Officer	Total annual amount of transactions	Total annual operating revenues of the Company and its major subsidiaries	Less than 1%
		Annual net sales of the company	Less than 1%
Berlitz Corporation, where Ms. Yukako Uchinaga previously served as Representative Director, Chairman of the Board, President & CEO	Total annual amount of transactions	Total annual operating revenues of the Company and its major subsidiaries	Less than 1%
		Annual net sales of the company	Less than 1%
Benesse Holdings, Inc., where Ms. Yukako Uchinaga previously served as Director and Executive Vice President	Total annual amount of transactions	Total annual operating revenues of the Company and its major subsidiaries	Less than 1%
		Annual net sales of the company	Less than 1%
Global Research Institute Co., Ltd., where Ms. Yukako Uchinaga currently serves as President and CEO	Total annual amount of transactions	Total annual operating revenues of the Company and its major subsidiaries	Less than 1%
		Annual net sales of the company	Less than 1%

\* Please refer to page 49 for details on the Company's independence standards for independent officers.

- Notes: 1. Ms. Yukako Uchinaga is a candidate for outside Member of the Board. In addition, as stated in the above matters regarding independence, as Ms. Yukako Uchinaga fulfills the independence criteria stipulated by the Tokyo Stock Exchange, on which the Company is listed, and the Company's own independence standards for independent officers, and there is no concern that conflicts of interest with general shareholders would arise, the Company has designated her as an independent officer and filed the information related thereto with the aforementioned stock exchange. The Company plans to designate Ms. Yukako Uchinaga as an independent officer should her election be approved.
2. In order for Ms. Yukako Uchinaga to fully perform her expected role as an outside Member of the Board, pursuant to the provisions of Article 427, paragraph (1) of the Companies Act, the Company plans to enter into agreement with the candidate limiting her liability for damages pursuant to Article 423, paragraph (1) of the same act. The maximum amount of liability for damages pursuant to such agreement is the minimum liability amount stipulated in Article 425, paragraph (1) of the Companies Act.



## 8 Ryoji Chubachi

(September 4, 1947)

New election

Outside

Independent

Number of shares of the Company held:  
0 shares



### Career summary, position, responsibilities and description of significant concurrent positions

April 1977:	Joined Sony Corporation
June 2005:	President Representative Corporate Executive Officer Member of the Board of Sony Corporation
April 2009:	Vice Chairman Representative Corporate Executive Officer Member of the Board of Sony Corporation (retired on March 31, 2013)
April 2013:	President of National Institute of Advanced Industrial Science and Technology (incorporated administrative agency; currently national research and development institution)
June 2018:	Director of JAPAN POST BANK Co., Ltd. (present post)
April 2020:	Grand Emeritus Advisor of National Institute of Advanced Industrial Science and Technology (present post)

### Reasons for Election as an Outside Member of the Board and Overview of Expected Roles

Mr. Ryoji Chubachi has a wealth of experience as a corporate manager and the person responsible for operating a research institution, and has a high level of integrity and insight. The Company therefore believes that he will help strengthen the supervisory function for business execution and expects to incorporate the advice he provides from his wide-ranging perspective on management.

### Matters regarding independence

Although the Company and its major subsidiaries have relationships involving transactions with Sony Corporation, where Mr. Ryoji Chubachi previously served as President, Representative Corporate Executive Officer and Member of the Board, and National Institute of Advanced Industrial Science and Technology, where he currently serves as Grand Emeritus Advisor, as shown in the table below, both cases fulfill the independence criteria stipulated by the Tokyo Stock Exchange, on which the Company is listed, and the Company's own independence standards for independent officers.\*

Transaction counterparty	Content	Comparison basis	Comparative size
Sony Corporation, where Mr. Ryoji Chubachi previously served as President, Representative Corporate Executive Officer and Member of the Board	Total annual amount of transactions	Total annual operating revenues of the Company and its major subsidiaries	Less than 1%
		Annual net sales of the company	Less than 1%
National Institute of Advanced Industrial Science and Technology, where Mr. Ryoji Chubachi currently serves as Grand Emeritus Advisor	Total annual amount of transactions	Total annual operating revenues of the Company and its major subsidiaries	Less than 1%

\* Please refer to page 49 for details on the Company's independence standards for independent officers.

Notes: 1. Mr. Ryoji Chubachi is a candidate for outside Member of the Board.

In addition, as stated in the above matters regarding independence, as Mr. Ryoji Chubachi fulfills the independence criteria stipulated by the Tokyo Stock Exchange, on which the Company is listed, and the Company's own independence standards for independent officers, and there is no concern that conflicts of interest with general shareholders would arise, the Company has designated him as an independent officer and filed the information related thereto with the aforementioned stock exchange. The Company plans to designate Mr. Ryoji Chubachi as an independent officer should his election be approved.

- In order for Mr. Ryoji Chubachi to fully perform his expected role as an outside Member of the Board, pursuant to the provisions of Article 427, paragraph (1) of the Companies Act, the Company plans to enter into agreement with the candidate limiting his liability for damages pursuant to Article 423, paragraph (1) of the same act. The maximum amount of liability for damages pursuant to such agreement is the minimum liability amount stipulated in Article 425, paragraph (1) of the Companies Act.

## 9 Koichiro Watanabe

(April 16, 1953)

New election

Outside

Independent

Number of shares of the Company held:  
0 shares



### Career summary, position, responsibilities and description of significant concurrent positions

April 1976:	Joined The Dai-ichi Mutual Life Insurance Company
April 2010:	Representative Director President of The Dai-ichi Life Insurance Company, Limited
October 2016:	Representative Director President of Dai-ichi Life Holdings, Inc.
October 2016:	Representative Director President of The Dai-ichi Life Insurance Company, Limited (A new company that took over the domestic life insurance business)
April 2017:	Representative Director Chairman of the Board of Dai-ichi Life Holdings, Inc.
April 2017:	Representative Director Chairman of the Board of The Dai-ichi Life Insurance Company, Limited
March 2018:	Member of the Board of Japan Tobacco Inc. (retired on March 24, 2021)
June 2020:	Director Chairman of the Board of Dai-ichi Life Holdings, Inc. (present post)
June 2020:	Director Chairman of the Board of The Dai-ichi Life Insurance Company, Limited (present post)

### Reasons for Election as an Outside Member of the Board and Overview of Expected Roles

Mr. Koichiro Watanabe has a wealth of experience as a corporate manager, and has a high level of integrity and insight. The Company therefore believes that he will help strengthen the supervisory function for business execution and expects to incorporate the advice he provides from his wide-ranging perspective on management.

### Matters regarding independence

Although the Company and its major subsidiaries have relationships involving transactions with Dai-ichi Life Holdings, Inc. and The Dai-ichi Life Insurance Company, Limited, where Mr. Koichiro Watanabe currently serves as Director and Chairman of the Board, as shown in the table below, both cases fulfill the independence criteria stipulated by the Tokyo Stock Exchange, on which the Company is listed, and the Company's own independence standards for independent officers.\*

Transaction counterparty	Content	Comparison basis	Comparative size
Dai-ichi Life Holdings, Inc., where Mr. Koichiro Watanabe currently serves as Director and Chairman of the Board	Total annual amount of transactions	Total annual operating revenues of the Company and its major subsidiaries	Less than 1%
		Annual net sales of the company	Less than 1%
The Dai-ichi Life Insurance Company, Limited, where Mr. Koichiro Watanabe currently serves as Director and Chairman of the Board	Total annual amount of transactions	Total annual operating revenues of the Company and its major subsidiaries	Less than 1%
		Annual net sales of the company	Less than 1%

\* Please refer to page 49 for details on the Company's independence standards for independent officers.

Notes: 1. Mr. Koichiro Watanabe is a candidate for outside Member of the Board.

In addition, as stated in the above matters regarding independence, as Mr. Koichiro Watanabe fulfills the independence criteria stipulated by the Tokyo Stock Exchange, on which the Company is listed, and the Company's own independence standards for independent officers, and there is no concern that conflicts of interest with general shareholders would arise, the Company has designated him as an independent officer and filed the information related thereto with the aforementioned stock exchange. The Company plans to designate Mr. Koichiro Watanabe as an independent officer should his election be approved.

- In order for Mr. Koichiro Watanabe to fully perform his expected role as an outside Member of the Board, pursuant to the provisions of Article 427, paragraph (1) of the Companies Act, the Company plans to enter into agreement with the candidate limiting his liability for damages pursuant to Article 423, paragraph (1) of the same act. The maximum amount of liability for damages pursuant to such agreement is the minimum liability amount stipulated in Article, paragraph 425, paragraph (1) of the Companies Act.



### Career summary, position, responsibilities and description of significant concurrent positions

June 1994:	Joined DIAMOND, Inc.
April 2004:	Concurrently serve as Director of Kyushu University Tokyo Office (retired on March 31, 2006)
March 2006:	Deputy Editor of Diamond Weekly of DIAMOND, Inc. (retired on December 31, 2013)
September 2013:	Visiting Researcher at Policy Alternatives Research Institute of the University of Tokyo (retired on August 31, 2018)
April 2015:	Project Professor of Graduate School of Media and Governance of Keio University (retired on March 31, 2020)
June 2016:	Member of the Board of Directors of NTT DOCOMO, INC. (scheduled to retire on June 21, 2022)
July 2018:	Director of AIN HOLDINGS INC. (present post)
June 2019:	Director of Hankyu Hanshin Holdings, Inc. (present post)
April 2020:	Project Professor of Keio University Global Research Institute (present post)
March 2021:	Director of Techpoint, Inc. (present post)
June 2021:	Director of Japan Elevator Service Holdings Co., Ltd. (present post)

### Reasons for Election as an Outside Member of the Board and Overview of Expected Roles

Ms. Noriko Endo has a wealth of experience cultivated through her career, including interviewing activities as the editor of a financial magazine, conducting research on public policy (in the energy field, etc.), and serving as an outside director of corporations, and has a high level of integrity and insight. The Company therefore believes that she will help strengthen the supervisory function for business execution and expects to incorporate the advice she provides from her wide-ranging perspective.

### Matters regarding independence

Although the Company and its major subsidiaries have relationships involving transactions and donations with the DIAMOND, Inc., where Ms. Noriko Endo previously served, and Keio University, where Ms. Noriko Endo currently serves as a Project Professor, as shown in the table below, the case fulfills the independence criteria stipulated by the Tokyo Stock Exchange, on which the Company is listed, and the Company's own independence standards for independent officers.\*

Transaction counterparty	Content	Comparison basis	Comparative size
DIAMOND, Inc., where Ms. Noriko Endo previously served	Total annual amount of transactions	Total annual operating revenues of the Company and its major subsidiaries	Less than 1%
		Annual net sales of the company	Less than 1%
Keio University, where Ms. Noriko Endo currently serves as a Project Professor	Total annual amount of transactions	Total annual operating revenues of the Company and its major subsidiaries	Less than 1%
		Total annual income of the university	Less than 1%
	Total annual amount of donations	—	Less than ¥10 million annually

\* Please refer to page 49 for details on the Company's independence standards for independent officers.

Notes: 1. Ms. Noriko Endo is a candidate for outside Member of the Board.

Ms. Noriko Endo has not previously been involved in the management of a company other than by way of becoming an outside member of the board or outside audit & supervisory board member. However, as stated in the above reasons for election as an outside Member of the Board, the Company determined that she is capable of adequately serving as an outside Member of the Board.

In addition, as stated in the above matters regarding independence, as Ms. Noriko Endo fulfills the independence criteria stipulated by the Tokyo Stock Exchange, on which the Company is listed, and the Company's own independence standards for independent officers, and there is no concern that conflicts of interest with general shareholders would arise, the Company has designated her as an independent officer and filed the information related thereto with the aforementioned stock exchange. The Company plans to designate Ms. Noriko Endo as an independent officer should her election be approved.

- In order for Ms. Noriko Endo to fully perform her expected role as an outside Member of the Board, pursuant to the provisions of Article 427, paragraph (1) of the Companies Act, the Company plans to enter into agreement with the candidate limiting her liability for damages pursuant to Article 423, paragraph (1) of the same act. The maximum amount of liability for damages pursuant to such agreement is the minimum liability amount stipulated in Article 425, paragraph (1) of the Companies Act.
- Ms. Noriko Endo has been a non-executive director (Outside Member of the Board of Directors) of the Company's subsidiary NTT DOCOMO, INC. in the past.

## Fourth Item Election of Two (2) Audit & Supervisory Board Members

Audit & Supervisory Board Member Takao Maezawa will resign at the conclusion of this Ordinary General Meeting of Shareholders. The Company is seeking approval for the election of one Audit & Supervisory Board member to replace him and the election of one outside Audit & Supervisory Board Member to further enhance and strengthen the audit system.

Audit & Supervisory Board supports this proposal.

The candidates for Audit & Supervisory Board Member are as follows:

### 1 Keiichiro Yanagi (August 16, 1960) New election

Number of shares of the Company held:  
0 shares



#### Career summary, position and description of significant concurrent positions

April 1984:	Joined Nippon Telegraph and Telephone Public Corporation
April 2009:	President and Representative Director of NTT DATA Getronics Corporation (currently NTT DATA Luweave Corporation)
June 2012:	Head of General Affairs Department of NTT DATA Corporation
July 2013:	Senior Vice President Head of Second Financial Sector of NTT DATA Corporation
June 2016:	Director and Executive Vice President Head of General Affairs Department Concurrently serving as Head of Human Resources Department of NTT DATA Corporation
July 2017:	Director and Executive Vice President Head of HR Headquarters Concurrently serving as Head of General Affairs Department of NTT DATA Corporation
June 2018:	Representative Director and Senior Executive Vice President Concurrently serving as Head of HR Headquarters of NTT DATA Corporation
June 2020:	Executive Advisor of NTT DATA Corporation (scheduled to retire on June 16, 2022)
June 2020:	CEO and President of NTT DATA INSTITUTE OF MANAGEMENT CONSULTING, Inc. (scheduled to retire on June 14, 2022)

#### Reasons for Election as an Audit & Supervisory Board Member

Mr. Keiichiro Yanagi has served as Representative Director and Senior Executive Vice President of NTT DATA Corporation. The Company expects that he will conduct future audits based on a wealth of experience and insight he has gained throughout his career.

Note: In order for Mr. Keiichiro Yanagi to fully perform his expected role as an outside Audit & Supervisory Board Member, pursuant to the provisions of Article 427, paragraph (1) of the Companies Act, the Company plans to enter into agreement with the candidate limiting his liability for damages pursuant to Article 423, paragraph (1) of the same act. The maximum amount of liability for damages pursuant to such agreement is the minimum liability amount stipulated in Article 425, paragraph (1) of the Companies Act.

## 2 Kensuke Koshiyama

(June 17 1960)

New election

Outside

Independent

Number of shares of the Company held:  
0 shares



### Career summary, position and description of significant concurrent positions

April 1984: Joined Board of Audit of Japan  
December 2016: Senior ASG of Secretariat of Board of Audit of Japan  
April 2017: Director General of 2nd Bureau of Board of Audit of Japan  
April 2018: Deputy Secretary General of Board of Audit of Japan  
December 2018: Secretary General of Board of Audit of Japan (retired on December 31, 2021)

### Reasons for Election as an Outside Audit & Supervisory Board Member

Mr. Kensuke Koshiyama has worked for the Board of Audit of Japan for many years. The Company expects that he will conduct future audits based on a wealth of experience and insight in auditing finance, accounting, and execution of duties he has gained throughout his career.

### Matters regarding independence

Although the Company and its major subsidiaries have relationships involving transactions with the Board of Audit of Japan, where Mr. Kensuke Koshiyama previously served as Secretary General, as shown in the table below, the case fulfills the independence criteria stipulated by the Tokyo Stock Exchange, on which the Company is listed, and the Company's own independence standards for independent officers.\*

Transaction counterparty	Content	Comparison basis	Comparative size
Board of Audit of Japan, where Mr. Kensuke Koshiyama previously served as Secretary General	Total annual amount of transactions	Total annual operating revenues of the Company and its major subsidiaries	Less than 1%

\* Please refer to page 49 for details on the Company's independence standards for independent officers.

Notes: 1. Mr. Kensuke Koshiyama is a candidate for outside Audit & Supervisory Board

Mr. Kensuke Koshiyama has not previously been involved in the management of a company other than by way of becoming an outside member of the board or outside audit & supervisory board member. However, as stated in the above reasons for election as an outside Member of the Board, the Company has determined that he is capable of adequately serving as an outside Audit & Supervisory Board Member.

In addition, as stated in the above matters regarding independence, as Mr. Kensuke Koshiyama fulfills the independence criteria stipulated by the Tokyo Stock Exchange, on which the Company is listed, and the Company's own independence standards for independent officers, and there is no concern that conflicts of interest with general shareholders would arise, the Company has designated him as an independent officer and filed the information related thereto with the aforementioned stock exchange. The Company plans to designate Mr. Kensuke Koshiyama as an independent officer should his election be approved.

2. In order for Mr. Kensuke Koshiyama to fully perform his expected role as an outside Audit & Supervisory Board Member, pursuant to the provisions of Article 427, paragraph (1) of the Companies Act, the Company plans to enter into agreement with the candidate limiting his liability for damages pursuant to Article 423, paragraph (1) of the same act. The maximum amount of liability for damages pursuant to such agreement is the minimum liability amount stipulated in Article 425, paragraph (1) of the Companies Act.

## List of Candidates for Members of the Board and Audit & Supervisory Board Members and Skills of Each Candidate (In Cases Each Candidate Is Elected at the Ordinary General Meeting of Shareholders)

The fields considered especially important by the Company for realizing the NTT Group's Medium-Term Management Strategy are defined as 1) Business management, 2) Marketing/global business, 3) IT/DX/R&D, 4) Legal/risk management/public policy, 5) HR, 6) Accounting/finance. The skills of individual Members of the Board are also well-balanced and appropriately distributed. A list is presented in the table below.

Candidate No.		Name	Current Position and Responsibilities			
Members of the Board	Third Item	1	<b>Jun Sawada</b>	Representative Member of the Board President and Chief Executive Officer (CEO)	Reelection	
		2	<b>Akira Shimada</b>	Representative Member of the Board Senior Executive Vice President In charge of business strategy Chief Financial Officer (CFO) Chief Compliance Officer (CCO) Chief Human Resource Officer (CHRO)	Reelection	
		3	<b>Katsuhiko Kawazoe</b>	Executive Vice President Head of Research and Development Planning	New election	
		4	<b>Takashi Hiroi</b>	Senior Executive Vice President Representative Member of the Board of Directors of NTT DOCOMO, INC. Responsible for Global business, Corporate, Finance, Business alliance and Strategic alliance	New election	
		5	<b>Akiko Kudo</b>	Senior Vice President Head of Public Relations Deputy Head of Business Strategy	New election	
		6	<b>Ken Sakamura</b>	Member of the Board	Reelection	Outside Independent
		7	<b>Yukako Uchinaga</b>	—	New election	Outside Independent
		8	<b>Ryoji Chubachi</b>	—	New election	Outside Independent
		9	<b>Koichiro Watanabe</b>	—	New election	Outside Independent
		10	<b>Noriko Endo</b>	—	New election	Outside Independent
Audit & Supervisory Board Members	Fourth Item	1	<b>Keiichiro Yanagi</b>	CEO and President of NTT DATA INSTITUTE OF MANAGEMENT CONSULTING, Inc.	New election	
		—	<b>Kanae Takahashi</b>	Full-time Audit & Supervisory Board Member	—	
		2	<b>Kensuke Koshiyama</b>	—	New election	Outside Independent
		—	<b>Takashi Iida</b>	Audit & Supervisory Board Members	—	Outside Independent
		—	<b>Hideki Kanda</b>	Audit & Supervisory Board Members	—	Outside Independent
		—	<b>Kaoru Kashima</b>	Audit & Supervisory Board Members	—	Outside Independent

- (Notes) 1. Up to five fields in which expectations for individual Members of the Board/Audit & Supervisory Board Members are particularly high are listed. The following table is not an exhaustive list of the knowledge and experience possessed by each Member of the Board or Audit & Supervisory Board Member.
2. NTT has entered into a directors and officers liability insurance policy as provided for in Article 430-3, paragraph (1) of the Companies Act with an insurance company, whereby all of its Members of the Board and Audit & Supervisory Board Members constitute the insured. This insurance policy covers the insured's losses and such costs as related litigation expenses incurred from claims for damages arising from acts (including nonfeasance) carried out by the insured as an officer or a person at a certain position of the Company. However, losses and costs personally incurred by the insured as a result of the insured having engaged in criminal acts such as bribery and intentional illegal activities are not covered by the policy as a measure to ensure that the proper performance of duties by officers is not impaired. The respective candidates will constitute the insured under the insurance policy if the candidate is elected and assumes the office as Members of the Board and Audit & Supervisory Board Members. Moreover, when the policy is renewed, the Company plans to renew the policy with the terms above.

	Field					
	Business Management	Marketing/Global Business	IT/DX/R&D	Legal/Risk Management/ Public Policy	HR	Accounting/Finance
	●	●	●		●	●
	●	●		●	●	●
	●	●	●	●	●	
	●	●		●	●	●
	●	●	●			
	●	●	●			
	●	●	●			
	●	●	●			
	●	●	●			●
	●		●	●		
		●		●	●	●
			●	●	●	●
				●	●	●
				●	●	●
				●	●	●
				●	●	●

# Business Report (For the Fiscal Year ended March 31, 2022)

## Value Creation Process ~Cycle to Realize Ongoing Improvements of Corporate Value~

The Company's attributes include a solid customer base in Japan and overseas, global brand power, human resource capabilities, and world-class research and development capabilities. We will leverage these to sustainably increase our corporate value in a manner unique to NTT through digital transformation together with our partners.

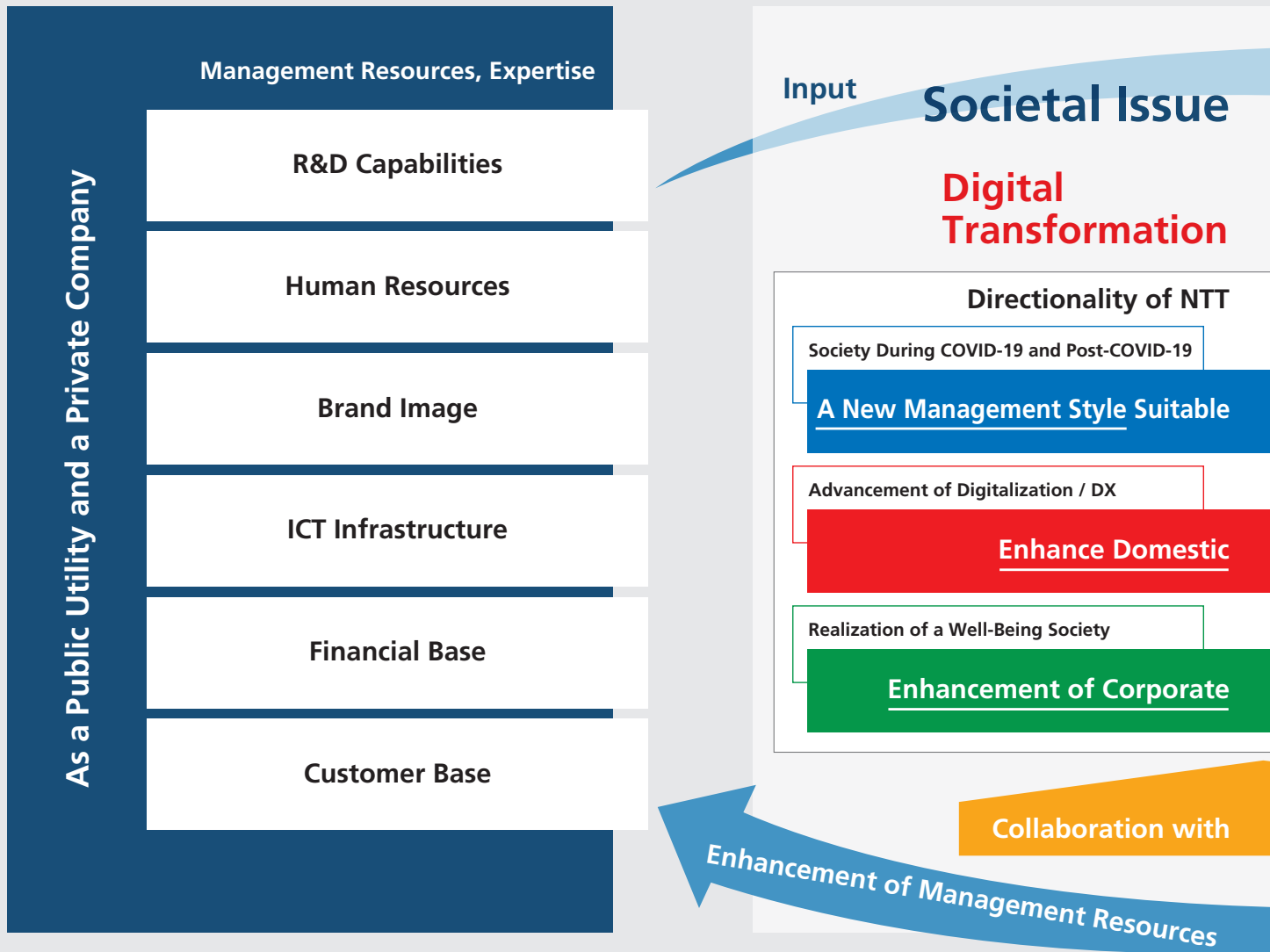



Contribute to  
Realization of  
Smart World  
/Society 5.0

Towards  
a sustainable  
society/SDGs



Resolution  
through Business Operation

Outcome

× CSR

Group's Transformation

for a Decentralized Network Society

and Global Business

Value through ESG Initiatives

Various Partners

### Medium-Term Financial Targets

New Targets  
(Announced in October 2021)

Prior Targets

<FY2022 Targets>

#### EPS

¥370/share  
(FY2023)

Approx. ¥320/share  
(FY2023)

<¥340/share>

#### Overseas Operating Profit Margin\*1

7%  
(FY2023)

7%  
(FY2023)

<7.0%>  
(Expected to achieve  
target one year early)

#### Cost Reductions\*2 (in fixed-line/mobile access networks)

at least ¥1 trillion  
(FY2023)

at least ¥800 billion  
(FY2023)

<¥930 billion>

#### ROIC Return on invested capital

8%  
(FY2023)

8%  
(FY2023)

<7.6%>

### Major sustainability targets

<FY2022 Targets>

#### Greenhouse gas emissions\*3

Carbon neutral  
(FY2040)

<3.075 million tons or less>  
(Down 34% from FY2013)

#### B2B2X revenues

¥600 billion  
(FY2023)

<¥600 billion>  
(Expected to achieve target one year early)

#### Ratio of women newly promoted to management positions

Continue at 30% every year

<30%>

\*1 The scope of aggregation is the subsidiaries (NTT DATA International Business, NTT Ltd., NTT Communications International Business, etc.) belonging to NTT, Inc. when the Medium-Term Management Strategy was established.

Calculation of overseas operating profit margin excludes temporary expenses, such as M&A-related amortization costs of intangible fixed assets.

\*2 Figures show cumulative reductions since FY2017.

\*3 Target: GHG protocol Scope 1 + 2

# I Outline of the Business of NTT Group

## Consolidated Financial Results (IFRS)

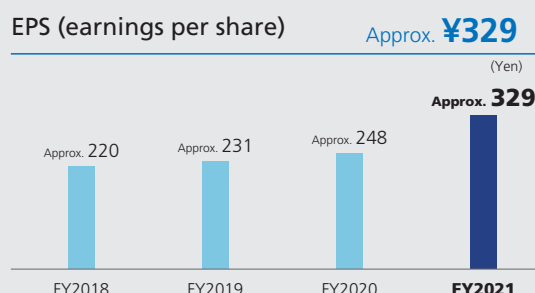
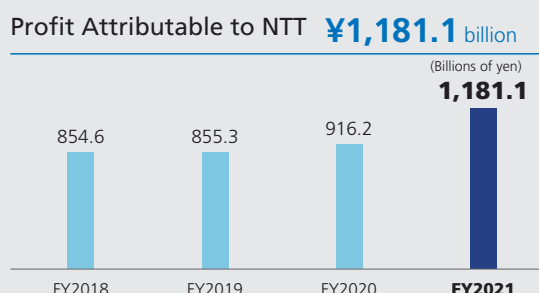
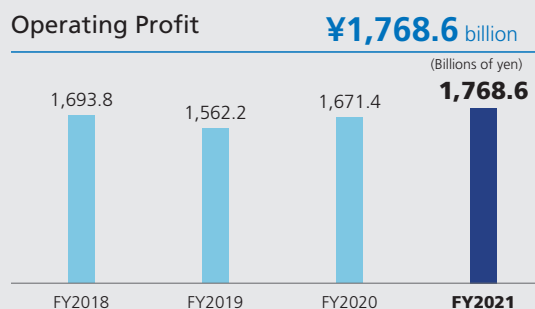
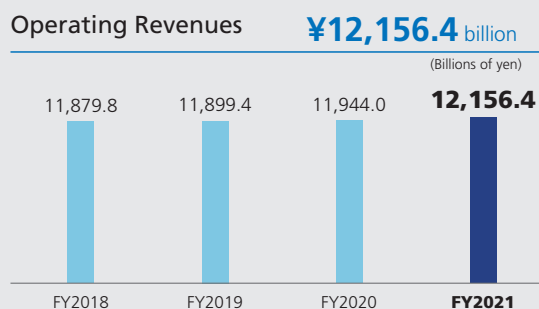

Note: NTT implemented a two-for-one stock split of common stock with an effective date of January 1, 2020. The figures for EPS have been adjusted to reflect the stock split.

## 1. Business Progress and Results

### ■ (1) Business Environment

In the fiscal year ended March 31, 2022, the information and telecommunications market saw initiatives towards digitalization accelerate with the expansion of cloud services and 5G services and the rapid advance of technologies such as IoT, big data and AI. In conjunction with this, the analysis and utilization of data (data management) accumulated through the use of such services are driving a global digital transformation resulting in reforms that will further take in a positive direction, such as by improving the convenience of people's daily lives, creating new business models and enhancing productivity.

Meanwhile, society needs to take steps such as strengthening information security against increasingly sophisticated and complex cyberattacks, reinforcing anti-disaster measures, and contributing to the protection of the environment, as well as shifting to a decentralized network society aligned with transformation in community life due to the COVID-19 pandemic.

The role of information and telecommunications is also becoming more important in terms of resolving these wide-ranging societal issues.

## ■ (2) Business Status

In this business environment, NTT Group refined its Medium-Term Management Strategy during the fiscal year under review and promoted initiatives aimed at contributing to the realization of a sustainable society through transformation to a new management style, enhancing domestic and global business, and enhancement of corporate value.

### Transformation to a New Management Style

We worked on transformation of business and digital transformation, re-examination of systems and general improvements, promotion of work-in-life (health management), and open, global, and innovative business operations.

#### [Transformation of Business and Digital Transformation]

- Zero trust systems have been introduced at the Company, NTT Communications, and NTT DATA, to allow all staff and personnel of sales organizations to work at any time in any location. (NTT DOCOMO, NTT East and NTT West are scheduled for introduction in FY2022.)

#### [Re-examination of Systems and General Improvements]

- In October 2021, the job-based personnel system was expanded to cover all managers in order to promote the optimal allocation of human resources regardless of number of years of service or age.

#### [Promotion of work-in-life (health management), and Open, Global, and Innovative Business Operations]

- We have been working to improve the environment for expanding the number of organizations subject to remote work through digital transformation, such as major contact centers, and expanding the development of satellite offices.

### Enhance Domestic and Global Business

We worked on growth and strengthening of the newly formed DOCOMO Group, promotion of the IOWN development/rollout plan, enhancing competitiveness in global business, promoting B2B2X model, and strengthening of new businesses.

#### [Growth and Strengthening of the New DOCOMO Group]

- In October 2021, NTT DOCOMO announced its New DOCOMO Group Medium-Term Strategy, and in January 2022, NTT DOCOMO made NTT Communications and NTT Comware its subsidiaries. By integrating the functions of the three companies, we aim to expand enterprise business, to strengthen competitiveness of the network, to enhance service creation and development capabilities, and to promote digital transformation.

#### Synergies through Integration

##### Expansion of enterprise business

Integrate all enterprise business under the New DOCOMO Group; support all corporate customers through one stop – contribute toward DX of society and industry

##### More competitive network

Fixed and Mobile convergence brings higher quality and economical network; provide inexpensive cost, easy-to-use services and accelerate evolution toward 6G / IOWN

##### Strengthening the power of service creation and development and promoting DX

Integrate R&D of DOCOMO, services of Communications and software capability of COMWARE, leading to quick response in creating innovative services, and accelerating DX of the New DOCOMO Group

### **[Promotion of the IOWN Development and Rollout Plan]**

- We proceeded with various efforts toward realization of the IOWN (Innovative Optical and Wireless Network) concept announced in May 2019. (For details of these efforts, please refer to (3) Status of Fundamental Research & Development, etc. on page 28.)

### **[Enhance Competitiveness in Global Business]**

- In March 2022, NTT Group entered a strategic partnership with Macquarie Asset Management regarding NTT Group's data centers in Europe and North America. By maximizing investment efficiency and expanding growth investments even further in the data center business, NTT Group aims to provide high quality services to global corporations.

### **[Promote B2B2X Model]**

- Industry One, Inc. was established through joint investment with Mitsubishi Corporation to provide digital transformation services and began operations in July 2021. The company will provide a full range of services from planning to solutions for digital transformation by integrating Mitsubishi Corporation's industrial knowledge and our ICT technologies and working with a wide range of partner companies.

### **[Strengthening of New Businesses]**

- In January 2022, the Company obtained ISO 37106, a smart city operation-related international certification, for the first time in Japan in recognition for its human-centric, open, and collaborative urban development utilizing digital infrastructure in the Higashi-ku area of Nagoya City. We will contribute to solving social issues and realizing Society 5.0 by applying the knowledge and know-how gained through this project to urban development nationwide.

## **Enhancement of Corporate Value**

---

The Company promoted initiatives to reduce environmental impact based on its new environment and energy vision, disaster countermeasure initiatives, and enhancement of returns to shareholders.

### **[New Environment and Energy Vision]**

- In September 2021, we formulated NTT Green Innovation toward 2040 as a new environment and energy vision. In addition to ongoing energy-saving efforts, we aim to achieve carbon neutrality for the entire NTT Group by FY2040 by expanding the use of renewable energy and introducing IOWN that enables power saving.
- In March 2022, we began offering "docomo Denki Green,"\* an earth-friendly plan that actively utilizes renewable energy sources such as solar, wind, and geothermal power.

\*Effectively 100% renewable energy, including non-fossil certificates with renewable energy designations, etc.

### **[Disaster Countermeasure Initiatives]**

- In light of the increasing number of disasters that are becoming larger, more widespread, and more prolonged, we have been working to harden our facilities and speed up our restoration response.

### **[Enhancement of Returns to Shareholders]**

- We increased capital efficiency through continuous dividend increases and flexible share buybacks.

## Trends of Dividends and Share Buyback Amounts

■ Annual Dividend per Share of Common Stock  
 ● Dividend Payout Ratio

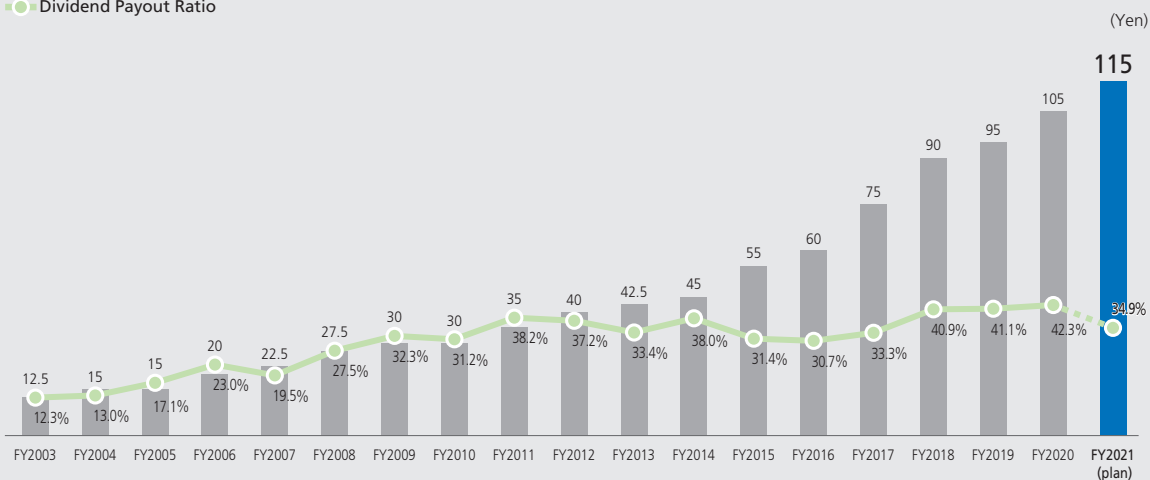

Notes: 1. NTT implemented a 100-for-one stock split of common stock with an effective date of January 4, 2009 and two-for-one stock splits of common stock with effective dates of July 1, 2015 and January 1, 2020. Figures for annual dividend per share of common stock have been adjusted to reflect these stock splits.  
 2. Beginning in the fiscal year ended March 31, 2019, NTT has applied IFRS, with the dividend payout ratio of the fiscal year ended March 31, 2018 also being recalculated under IFRS.

■ Amount of Share Buybacks

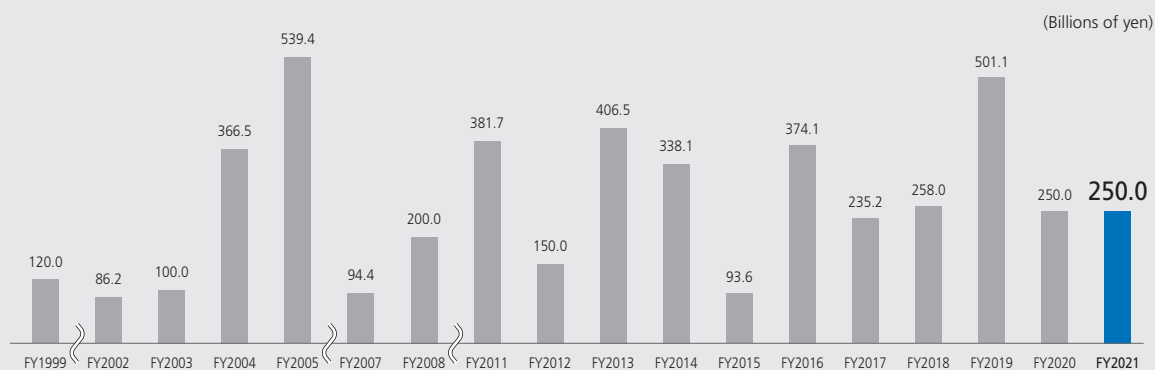

## Establishment of NTT Group Sustainability Charter

In November 2021, we reviewed our previous CSR Charter and established the global-level NTT Group Sustainability Charter. The new charter is based on the concept of “Self as We\*,” and by promoting a variety of initiatives related to the three themes of (1) ensuring the positive coexisting of nature and humanity), (2) improving prosperity for all people and cultures, and (3) maximizing well-being for all, we will simultaneously achieve growth as a company and solve social issues, thereby contributing to the realization of a sustainable society.

\* The idea that the “Self” exists as a “Self” within a “We” (which consists of everything, including people, things and technology), and is supported by connections consisting of diverse people, things and technology

## Overview of Initiatives Based on the Sustainability Charter

Nine challenges and 30 activities are defined based on three themes.

Three Themes		Nine Challenges	30 Activities
Ensuring the positive coexisting of nature and humanity	Addressing environmental and energy issues	Moving toward a decarbonized society	1) Promoting energy conservation 2) Reducing power consumption by introducing IOWN technologies 3) Developing and expanding the use of renewable energy 4) Providing new services that contribute to carbon neutrality 5) Creating innovative environmental and energy technologies
		A commitment to a resource-recycling future	6) Increasing the reuse and recycling of communications equipment, mobile terminals, and other technologies 7) Reduction of plastic use and promotion of recycling 8) Proper treatment, storage and management of hazardous waste 9) Appropriate and efficient management of water resources
		A future where people and nature are in harmony	10) Thoroughly implementing environmental assessment 11) Contributing to natural ecosystem conservation
Improving prosperity for all people and cultures	Addressing social issues	Establish shared ethical standards	12) Establishing and thoroughly complying with ethical standards 13) Appropriately managing conduct risk 14) Thoroughly reinforcing corporate governance and compliance 15) Sharing high ethical standards with business partners
		Prepare for a new future with the power of technology	16) Promoting the B2B2X model 17) Protection and respect for intellectual property 18) Contribution to the revitalization of local communities and economies
		Moving toward a safe, secure, and resilient society	19) Ensuring the stability and reliability of services 20) Strengthening information security and personal information protection 21) Promoting a decentralized society based on remote work
Maximizing well-being for all	Addressing human rights, diversity and inclusion	Respect for human rights	22) Compliance with the NTT Group Global Human Rights Policy 23) Encouraging society as a whole to respect human rights
		Diversity and inclusion	24) Promoting recruitment, training, and education of diverse human resources and women’s advancement in the workplace 25) Encouraging of understanding of LGBTQ and promoting the advancement of disabled people 26) Support for balancing work and life such as childcare and nursing care
		Creating new work style models	27) Promoting remote work and other workplace models 28) Achieving zero fatal accidents as well as maintaining and promoting employee health 29) Supporting autonomous capacity development 30) Promoting paperless operations

### ■ (3) Status of Fundamental Research & Development, etc.

NTT Group is advancing innovative research and development with the aim of effecting global change. In preparation for realizing the IOWN concept, we engaged in research and development of component technologies and carried out initiatives for creating use-cases in various industries. Furthermore, we have promoted initiatives together with parties in a wide range of industrial fields in Japan and overseas, with the goal of enhancing industrial competitiveness and resolving social issues.

#### Image for IOWN Concept

IOWN comprises three main technology components: “all-photonics network” (APN) that uses optical technology; digital twin computing (DTC) that enables high-speed, real-time interaction between things and people in cyberspace; and Cognitive Foundation® (CF), in which these and various other ICT resources are efficiently managed.

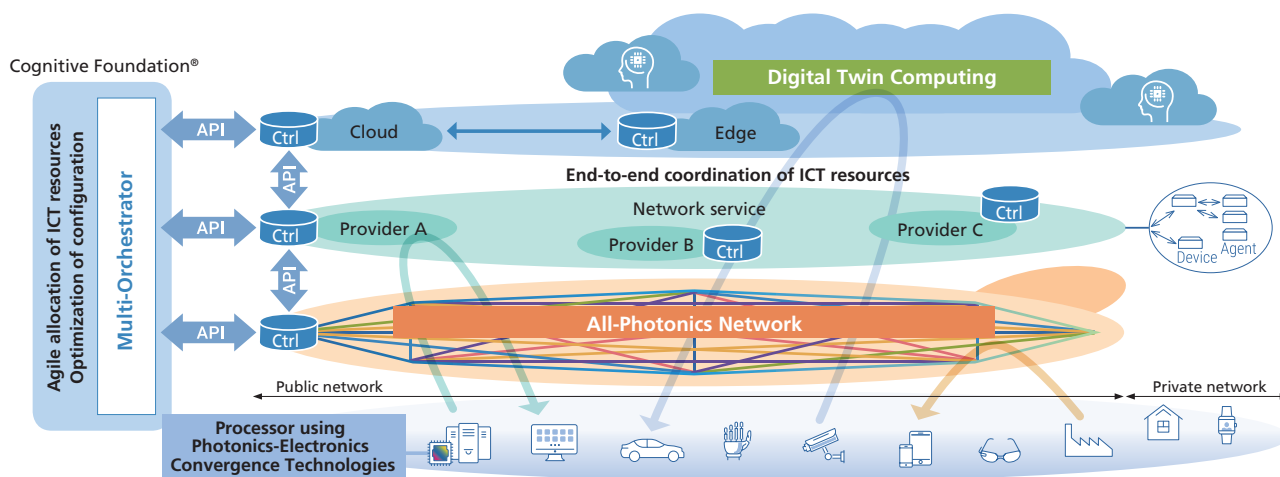

#### Research and Development in Preparation for Making the IOWN Concept a Reality

- In the research and development of photonics-electronics converged devices, which is the key to the IOWN concept, we have prepared a five-generation road map and we are working to create innovative technologies and quickly bring these technologies to practical application. In the past, NTT has succeeded in achieving practical application of coherent optical subassemblies (COSAs), which are miniature communication modules with optical interface functions for converting optical and electric signals. The Company recently built upon this success with the development of optical-electric co-packages that integrate COSAs, which have traditionally been used as standalone components, with digital signal processors. These new co-packages make it possible to reduce both the size and power consumption of optical interfaces.

## Photonics-electronics Converged Devices R&D Road Map

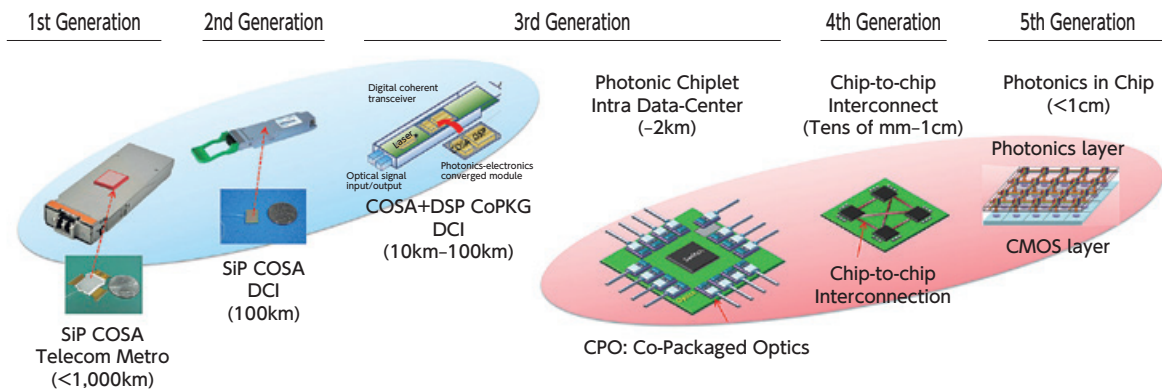

- Toward the realization of APN, we have constructed an experimental environment, which can dynamically provide optical paths between multiple points to accommodate user requests. The optical paths have the features of large capacity over 100 Gbps/lambda, extremely low latency fluctuation and absolute latency values. In disaggregated computing, in which distributed computer devices are connected optically, a new computer architecture (memory-centric architecture) was devised, and prototypes were developed. As a result of verifying the effectiveness of this architecture, we expected to reduce power consumption of approximately one-half that of the conventional method.
- As one of the initiatives utilizing the Urban DTC®, which optimizes the entire city through various future predictions and the linkage between digital twins, using the 4D digital platform® that grasps the entire city in real time and with precision, we established feed-forward AI air-conditioning control technology that enables comfort prediction based on short-term data and demonstrated its effectiveness in achieving both energy conservation and a comfortable environment. In addition, in order to realize “Another Me,” a digital twin of oneself, a philosophical redefinition of “I” that includes oneself and Another Me based on the “Self as We” view of oneself was created in collaboration with Kyoto University and presented.
- The IOWN Global Forum, established in January 2020, expanded to 93 member companies (as of March 2022), with the participation of major ICT companies from around the world that support IOWN’s vision of the world and its innovations. The first Annual Member Meeting was held in April 2021 and attended by over 400 people. In October 2021, two documents were created and published as use case documents, and in January 2022, six documents were created and published as technical documents.

## Promoting Collaboration Toward Realization of the IOWN Concept

- The Company and Fujitsu Limited concluded a strategic business alliance aimed at realizing a sustainable future digital society. Through the innovations created through this alliance, the two companies will collaborate globally and openly with a wide range of partners who support the IOWN concept, aiming to realize a new low-energy and highly efficient digital society.
- The Company and ACCESS CO., LTD. concluded a partnership aimed at realizing the IOWN concept. It will promote research and development of new user interfaces and user experiences for the IOWN era and leverage the structure of IP Infusion, a wholly owned subsidiary of ACCESS CO., LTD., and promote the development of a system to market the developed software products on the global market.



- The Company and SKY Perfect JSAT Holdings, Inc. concluded a business alliance for a new space business aimed at realizing a sustainable society. It will integrate multiple orbits, from the ground to high-altitude platforms flying in the stratosphere to low earth orbits and geostationary orbits in space, and connect them to the ground via an optical wireless communication network to accelerate various data processing through distributed computing, provide access to mobile terminals on the ground, and achieve ultra-wide service coverage, aiming at building a space integrated computing network.

### Space Integrated Computing Network

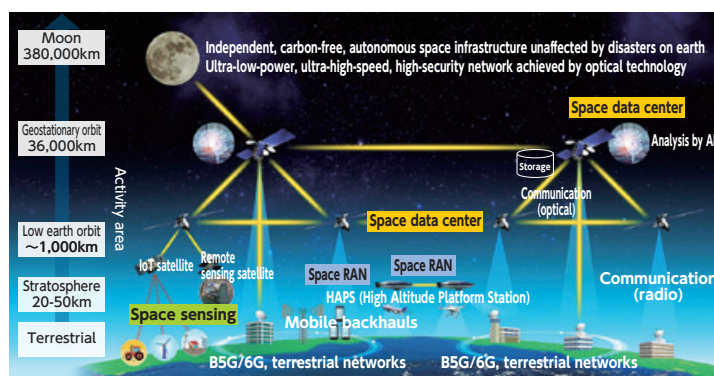

### Research and Development to Realize a Safe and Secure Society, Including Solutions to Environmental Problems

- We have developed a technology that can transform asbestos from a fiber shape to a spherical shape by irradiating it with a high-power laser. This technology can transform asbestos into a harmless spherical shape and suppress the amount of dust dispersed, thereby significantly reducing the health risks to workers due to inhalation of asbestos dust.
- In collaboration with NEC Corporation, we have developed a security transparency assurance technology that drastically reduces security risks by sharing the configuration and risks of telecommunications equipment and systems that make up the information and telecommunications infrastructure throughout the supply chain and by ensuring transparency regarding security.

### Promoting Cutting-Edge Research and Development

- For the purpose of promoting the research and development of the Company to realize the IOWN concept and beyond, we have formed the NTT R&D Authority Team, consisting of researchers who are renowned authorities in their respective fields, as well as establishing the Institute for Fundamental Mathematics, headed by Dr. Masato Wakayama, a member of the Authority Team who serves as the Fundamental Mathematics Research Principal, to further strengthen research and development from a long-term perspective.
- In the area of quantum computing, which faced a major challenge with regard to miniaturization to enable practical application due to the need for large-scale cooling and vacuum equipment, the Company, in cooperation with the University of Tokyo and RIKEN, has jointly developed a fiber-coupled quantum light source (squeezed light source), which is the key technology to realize a rack-sized large-scale optical quantum computer.

As a result of the above efforts, NTT Group's consolidated operating revenues for the fiscal year ended March 31, 2022 were 12,156.4 billion yen (an increase of 1.8% from the previous fiscal year) and consolidated operating expenses were 10,387.9 billion yen (an increase of 1.1% from the previous fiscal year). As a result, consolidated operating profit was 1,768.6 billion yen (an

increase of 5.8% from the previous fiscal year), consolidated profit before taxes was 1,795.5 billion yen (an increase of 8.7% from the previous fiscal year), and consolidated profit attributable to NTT was 1,181.1 billion yen (an increase of 28.9% from the previous fiscal year).

## (4) Status by Segment

### Main Businesses



#### Integrated ICT Business

The principal services in the Integrated ICT Business are mobile phone services, domestic inter-prefectural communications services, international communications services, solutions services, and system development services and related services.



#### Regional Communications Business

The principal services in the Regional Communications Business are domestic intra-prefectural communications services and related ancillary services.



#### Global Solutions Business

The principal services in the Global Solutions Business are system integration services, network system services, cloud services, global data center services, and related services.



#### Others (Real Estate, Energy and Others)

Others include the real estate business, energy business and others.



Other group companies

Operating Revenues\*  
(FY2021)  
¥12,156.4 billion

Operating Profit\*  
(FY2021)  
¥1,768.6 billion

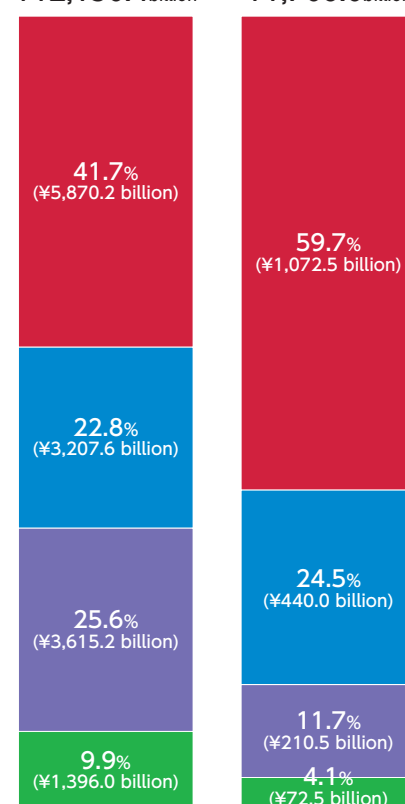

\* Percentage of simple sum of each segment (including intersegment transactions)

Note: For the strategic group-wide utilization of resources and assets and for speeding up decision-making, the Company has overhauled the corporate structure which has involved making NTT DOCOMO a wholly owned subsidiary in December 2020 and furthermore making NTT Communications and NTT Comware subsidiaries of NTT DOCOMO in January 2022. Accordingly, effective from the fiscal year ended March 31, 2022, NTT Group has transitioned to a four-segment structure consisting of the Integrated ICT Business, Regional Communications Business, Global Solutions Business, and Others (Real Estate, Energy and Others), from its previous five-segment structure consisting of the Mobile Communications Business, Regional Communications Business, Long Distance and International Communications Business, Data Communications Business, and Other Business. Operating revenues and operating profit for FY2020 presented on pages 32, 34 and 35 have been restated to align with the segment classifications subsequent to the change.

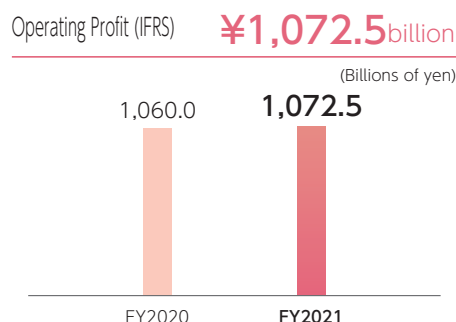
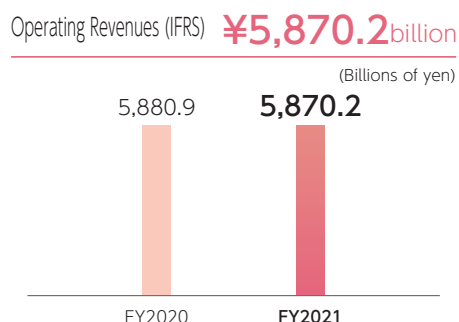

### Overview

In the Integrated ICT Business, in addition to promoting sales of 5G services and “docomo Hikari,” etc., for corporate business, we promoted initiatives for “docomo Business,” a corporate business brand unifying NTT DOCOMO, NTT Communications, and NTT Comware, to support all corporate customers with one-stop service. In the smart life area, we promoted collaborations with various businesses and worked to provide new added value.

### Details of Main Initiatives

- To meet the needs of customers seeking affordable options for their main plan, DOCOMO has agreed to collaborate with economy MVNO that utilizes d ACCOUNT® and d POINT to bolster its lineup of billing plans tailored to each customer’s lifestyle. Nationwide docomo Shops have begun handling the billing plans offered by economy MVNO.
- In December 2021, we started providing 5G services to corporate customers using the stand-alone method\*. Going forward, we will expand the services so that they can be used by customers in various industries and business categories, and work toward industrial development through the creation of new services and solutions. \*A method that uses 5GC, a core network facility dedicated to 5G, and 5G base stations.
- In October 2021, we launched “droppin™,” a service that allows users to search for and reserve workspace. By integrating contracts, payments, and space reservations with multiple providers of workspace, the service reduces the burden on companies related to managing payments and creating manuals on how to make reservations, thereby contributing to the further spread of flexible work.

### Number of Subscriptions for Major Services

- “Mobile telecommunications services”: 84.75 million subscriptions (increase of 2.12 million year-on-year)
- “docomo Hikari”: 7.26 million subscriptions (increase of 0.22 million year-on-year)

Operating Revenues (IFRS) **¥3,207.6billion**  
(Billions of yen)

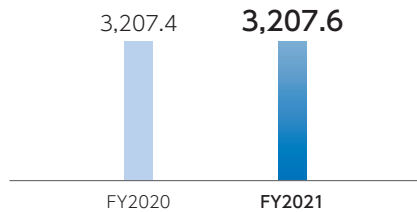

Operating Profit (IFRS) **¥440.0billion**  
(Billions of yen)

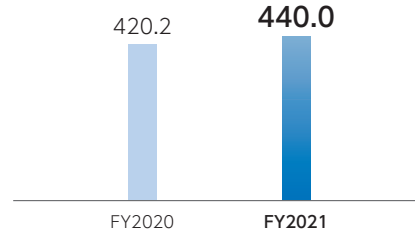

### Overview

In the Regional Communications Business Segment, we worked on the “Hikari Collaboration Model,” which provides wholesale fiber-optic access services, among other things, to various service providers, as well as strengthening our solutions business with the aim of revitalizing local communities and regional economies.

### Details of Main Initiatives

- In October 2021, NTT EDX CORPORATION, a company to work on the advancement of higher education, was established through joint investment with Dai Nippon Printing Co., Ltd. Centered on the electronic textbook and educational materials business, the company will provide various services to solve issues in higher education and support the digitization and streamlining of the operations of publishers and bookstores.
- In November 2021, the Company concluded a cooperation agreement with Tohoku Electric Power Co., Inc. and Tohoku Electric Power Network Co., Inc. related to initiatives to improve the operational efficiency of the infrastructure businesses and to solve regional issues, and in December 2021, a cooperation agreement with the HEPCO Group toward development of the region. The parties agreed to work together to improve operational efficiency in the infrastructure businesses that each company is responsible for, to improve disaster response capabilities, and to solve regional issues.
- In January 2022, NTT DX Partner was established to support the digital transformation of small and medium-sized enterprises and local governments. Leveraging its accumulated know-how in ICT utilization, deep ties with local communities, and abundant assets, the company will provide one-stop services ranging from digital transformation consulting to digital platform construction and operation, while making co-creation and running alongside customers, promoting solutions to regional issues and social issues.

### Number of Subscriptions for Major Services

- “FLET’S Hikari”: 23.27 million subscriptions (increase of 0.70 million year-on-year)
- (Included in the above) “Hikari Collaboration Model”: 16.29 million subscriptions (increase of 1.05 million year-on-year)

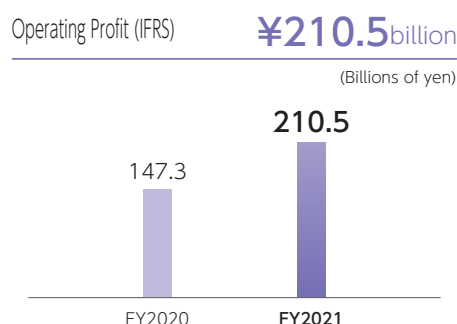
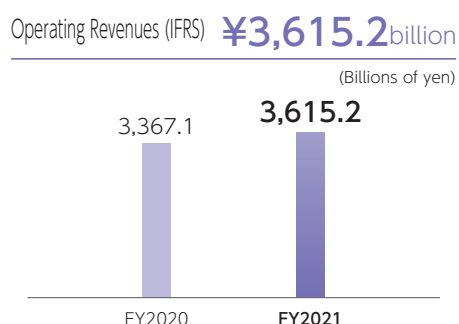

### Overview

In the Global Solutions Business, the Group worked to strengthen its ability to provide services in growth areas such as data center business and managed services, as well as to extend and consistently provide a range of IT services, such as offerings of digitalization and system integration, that are responsive to the changes in the market.

### Details of Main Initiatives

- In May 2021, NTT Group and Canada's Edmonton International Airport agreed to jointly develop a smart transportation project. It will utilize NTT Group's smart city technology to provide shuttle buses operating at the airport and surrounding facilities with optimal routes based on user demand, introducing an on-demand bus service.
- In July 2021, NTT established a local subsidiary in Israel with the aim of incorporating Israel's cutting-edge technology into NTT Group and creating new businesses. This will create an ecosystem for the creation of new businesses through synergies between Israeli companies and NTT Group. Specifically, we will strengthen relationships with startups, venture capital firms, and global companies in Israel to develop new businesses.
- In November 2021, we began offering the "Zero Trust Security Service," which provides a work environment tailored to flexible work styles, regardless of work location or type of device. Utilizing the know-how gained from the introduction and operation of zero trust environments used by NTT DATA Group employees, we will provide a full range of support services globally, from consulting to construction and operation of zero trust security.

## Others (Real Estate, Energy and Others)

Operating Revenues (IFRS) **¥1,396.0billion**  
(Billions of yen)

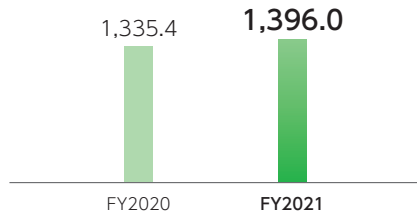

Operating Profit (IFRS) **¥72.5billion**  
(Billions of yen)

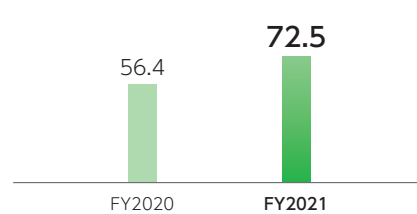

### Overview

We provided services related to real estate business and energy business, etc.

### Details of Main Initiatives

#### [Real Estate Business]

- Primarily through NTT Urban Solutions, Inc., a company that centralizes the functions of NTT Group's real estate business, we promoted office and retail operations, residential operations, and the global business. We took steps to contribute to urban development in local communities, such as by completing construction of a next-generation advanced office in Nagoya that contributes to regional revitalization, the achievement of SDGs, and decarbonization in January 2022.

#### [Energy Business]

- Centering on the activities of NTT Anode Energy Corporation, which promotes smart energy business, we worked to promote initiatives toward achieving NTT Group's new environment and energy vision (NTT Green Innovation toward 2040), including the development of renewable energy power plants, expanded utilization of NTT Group's assets, and deployment of decarbonization solutions, and worked toward realization of NTT Group and society becoming carbon neutral, local energy production and consumption, and strengthening resilience.

## 2. Issues to be Addressed

### ■ (1) Future Changes in the Environment

The decoupling of the world is accelerating due to COVID-19 pandemic and a remote/decentralized society is advanced. These situations make progress in digitalization and Digital Transformation (DX), on the other hand, negative aspect of digitalization such as surveillance society has appeared. In addition, our environment is dramatically changing with increasing the importance of economic security and scale of natural disasters worldwide.

### ■ (2) Business Development Based on the NTT Group Medium-Term Management Strategy

To respond to these changes in the environment, we refined the NTT Group Medium-Term Management Strategy announced in November 2018, and in October 2021, we established a new directionality of NTT Group's Transformation. In line with the social and economic directionality, we aim to contribute to the realization of a sustainable society through three reforms: a new management style that is suitable for the distributed network society, enhancing domestic and global business, and enhancement of corporate value through ESG initiatives.

#### Directionality of NTT Group's Transformation

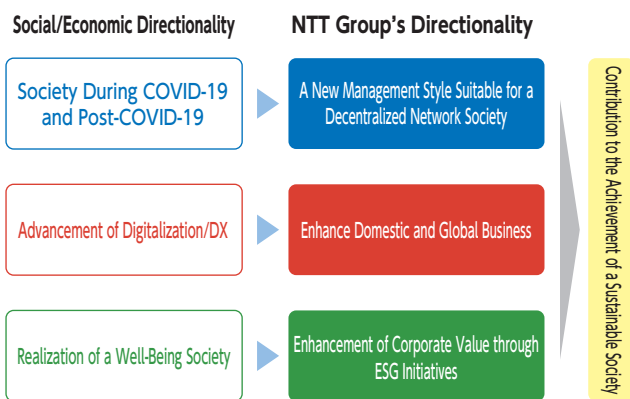

#### New Strategic Framework

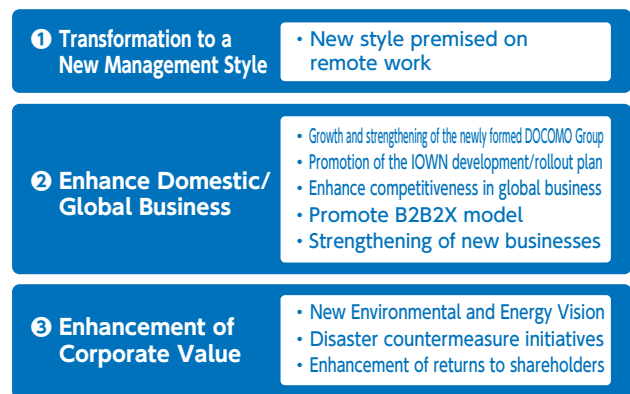

## Transformation to a New Management Style

---

We will promote remote work and work-in-life (health management), and realize open, global, and innovative business operations through transformation of business and digital transformation, re-examination of systems and general improvements. With regard to enhancement of governance in consideration of conduct risks, we will execute measures to maintain appropriate relationships with stakeholders, accurately manage the life cycles of services and other offerings, and improve crisis response capabilities.

By promoting our own transformation, we will also support our customers' digital transformation, promote regional development, improve resilience, and contribute to a decentralized society.

## Enhance Domestic and Global Business

---

We will work towards the growth and strengthening of the newly formed DOCOMO Group, promotion of the IOWN development/rollout plan, enhancing competitiveness in global business, promoting B2B2X model, and strengthening of new businesses.

In December 2020, we made NTT DOCOMO a wholly owned subsidiary with the aim of strengthening of NTT DOCOMO's competitiveness, its growth and the growth of NTT Group as a whole. NTT DOCOMO will take on the challenge of further growth through promoting function integration of NTT Communications and NTT Comware, which were made its subsidiaries in January 2022, and the seven initiatives set forth in the new DOCOMO Group Medium-Term Strategy (expansion of enterprise business, expansion of smart life business, strengthening telecommunications business, strengthening global business, strengthening IT, strengthening R&D, and promoting ESG).

Additionally, in May 2022, we announced realignment to strengthen the global businesses of NTT Group. NTT Group is moving the global businesses for business users operated by NTT DATA and NTT Ltd. within NTT DATA. This will allow for both companies to operate in a much more coordinated manner. By leveraging the combination of NTT DATA's capabilities such as consulting and application development and NTT Ltd.'s strength in high-value-added services such as data center, global networks, and managed services, NTT Group will be able to provide clients with new value as a whole. Also, in the long term, NTT Group will expand its innovative services utilizing NTT's IOWN technology in global markets. In addition, by bringing together the global talent of NTT Group, NTT Group will focus its human resources to realize more optimal and rapid decision making tailored to the needs of its business and clients in each region of the world while enhancing its global governance.



## Enhancement of Corporate Value

We will engage in initiatives to reduce our environmental impact based on our new environment and energy vision, as well as promoting disaster countermeasure initiatives and enhancement of returns to shareholders.

Under the new environment and energy vision, NTT Green Innovation toward 2040, we aim to simultaneously achieve the contradictory goals of zero environmental impact and economic growth by reducing the environmental impact of our business activities and creating innovations that break through limitations. In FY2030, NTT Group overall will reduce greenhouse gas emissions by 80% relative to FY2013, and mobile (NTT DOCOMO) and data centers will take the lead in achieving carbon neutrality. In FY2040, NTT Group overall will achieve carbon neutrality (targets are Scope 1+2).

### ■ (3) Medium-Term Financial Targets

We revised our financial targets in conjunction with the refinement of the Medium-Term Management Strategy (announced in October 2021).

We revised our previous FY2023 target for EPS, the main financial indicator, upward by ¥50 from ¥320 to ¥370. By generating synergies at the new DOCOMO Group (earnings growth of ¥100.0 billion in FY2023) and reducing costs through the promotion of digital transformation (reduction of at least ¥200.0 in FY2023), among others, we will work to achieve the EPS target, mainly through profit growth. The cost reduction target for cumulative reductions from FY2017 was increased from at least ¥800.0 billion of our previous FY2023 target to at least ¥1 trillion.

In addition, we will continue to promote various initiatives aimed at achieving our previously established financial targets for FY2023 of overseas operating profit margin of 7% and ROIC of 8%.

#### Medium-Term Financial Targets (Targets in FY2023)

Targets	New Targets (Announced in October 2021)	Prior Targets	(Reference) FY2022 Plan
EPS	¥370/share	Approx. ¥320/share	¥340/share
Overseas Operating Profit Margin* <sup>1</sup>	7%	7%	7.0%
Cost Reductions* <sup>2</sup> (in fixed-line/mobile access networks)	at least ¥1 trillion	at least ¥800 billion	¥930 billion
ROIC	8%	8%	7.6%

\*1 The scope of aggregation is the subsidiaries (NTT DATA International Business, NTT Ltd., NTT Communications International Business, etc.) belonging to NTT, Inc. when the Medium-Term Management Strategy was established.

Calculation of overseas operating profit margin excludes temporary expenses, such as M&A-related amortization costs of intangible fixed assets.

\*2 Figures show cumulative reductions since FY2017.

### 3. Capital Investment

NTT Group made a total of ¥1,687.6 billion of capital investments (a decrease of 2.4% from the previous fiscal year), focused on responding to customer demands for various services such as 5G and “FLET’S Hikari (including the Hikari Collaboration Model)” among others.

Category	Capital Investment (Billions of yen)
Integrated ICT Business	698.6
Regional Communications Business	501.1
Global Solutions Business	347.2
Others (Real Estate, Energy and Others)	140.7

### 4. External Financing

NTT Group procured long-term financing in the amount of ¥1,775.0 billion for bridge loan refinancing associated with having made NTT DOCOMO a wholly owned subsidiary, capital investment, and other purposes through long-term borrowings and issuance of bonds, such as green bonds.

Category	Amount (Billions of yen)
Corporate bonds	642.7
Long-term borrowings	1,132.3
Total	1,775.0

Note that the Company raised ¥1,388.0 billion as long-term borrowings from NTT FINANCE for purposes that include arranging bridge loan refinancing associated with having made NTT DOCOMO a wholly owned subsidiary and making loans to NTT East and NTT West.

## 5. Main Lenders and Outstanding Borrowings

Lender	Outstanding Borrowings (Billions of yen)
MUFG Bank, Ltd.	1,049.8
Mizuho Bank, Ltd.	615.5
Sumitomo Mitsui Banking Corporation	437.3
Sumitomo Mitsui Trust Bank, Limited	255.8
The Norinchukin Bank	170.4
Nippon Life Insurance Company	116.0
Meiji Yasuda Life Insurance Company	99.0
Development Bank of Japan Inc.	53.3
Shinkin Central Bank	50.0
Japan Bank for International Cooperation	38.9

## 6. Material Subsidiaries

Segment	Company	NTT's Equity Ownership Percentage (%)	Main Business Activities
Integrated ICT Business	NTT DOCOMO, INC.	100.00	Provision of mobile communication services and smart life area services
	NTT Communications Corporation	0 (100.00)	Provision of inter-prefectural communications services, international communications services and internet-related services
	NTT COMWARE CORPORATION	33.40 (100.00)	Development, production, operation and maintenance of information communications systems and software
	NTT Plala Inc.	0 (100.00)	Provision of internet connection services and video distribution services
Regional Communications Business	Nippon Telegraph and Telephone East Corporation	100.00	Provision of intra-prefectural communications services in the eastern part of Japan
	Nippon Telegraph and Telephone West Corporation	100.00	Provision of intra-prefectural communications services in the western part of Japan

Segment	Company	NTT's Equity Ownership Percentage (%)	Main Business Activities
Global Solutions Business	NTT, Inc.	100.00	Governance and strategy formulation, and promotion of measures in the global business of NTT Group
	NTT Ltd.	0 (100.00)	Provision of IT services and communications and internet-related services for corporations
	Dimension Data Holdings	0 (100.00)	IT system building and maintenance support for corporations
	NTT Security Corporation	0 (100.00)	Provision of professional security services
	NTT America	0 (100.00)	Provision of ICT services in North America
	NTT EUROPE	0 (100.00)	Provision of ICT services in Europe
	NTT Global Data Centers EMEA	0 (100.00)	Provision of data center-related services in Europe
	NTT Cloud Communications International Holdings	0 (100.00)	Provision of teleconference, web conference and video conference services
	NTT Global Data Centers Americas	0 (100.00)	Provision of data center-related services in North America
	NTT Global Networks	0 (100.00)	Provision of network services
	NETMAGIC SOLUTIONS	0 (100.00)	Provision of data center-related services in India
	NTT Global Data Centers EMEA UK	0 (100.00)	Provision of data center-related services in the UK
	NTT Managed Services Americas Intermediate Holdings	0 (100.00)	Provision of <u>managed services</u> in North America
	Transatel	0 (80.70)	Provision of mobile connectivity services for IoT
	NTT Security AppSec Solutions	0 (100.00)	Provision of security services
	Symmetry Holding	0 (100.00)	Provision of <u>managed services</u> in North America
	NTT DATA CORPORATION	0 (54.21)	Provision of data communications systems services and network system services
	NTT DATA	0 (100.00)	Consulting, system design and development in North America
	NTT DATA Services	0 (100.00)	Consulting, system design and development in North America
	NTT DATA Europe & Latam	0 (100.00)	Consulting, system design and development

Segment	Company	NTT's Equity Ownership Percentage (%)	Main Business Activities
Others (Real Estate, Energy and Others)	NTT Urban Solutions, Inc.	100.00	Contact point for urban solutions business, and integrated management of urban solutions-related information
	NTT URBAN DEVELOPMENT CORPORATION	0 (100.00)	Real estate acquisition, development, leasing, and management
	NTT FACILITIES, INC.	0 (100.00)	Design, management, and maintenance related to buildings, equipment, and electric power facilities
	NTT Anode Energy Corporation	100.00	Development of smart energy solutions and energy management system
	NTT FINANCE CORPORATION	100.00	Provision of billing and collection of charges for communications and other services, and credit card transaction settlement services

Notes: 1. The equity ownership percentages are calculated exclusive of the treasury stock each company owns. The figures in parentheses represent the equity ownership percentages of NTT's subsidiaries.

2. During the fiscal year under review, EVERIS PARTICIPACIONES changed its name to NTT DATA Europe & Latam.

3. The status of specific wholly owned subsidiary as of March 31, 2022 is as follows:

Name	Address	Total Book Value of Shares of Specific Wholly Owned Subsidiary at the Company	Total Assets of NTT
NTT DOCOMO, INC.	11-1, Nagata-cho 2-chome, Chiyoda-ku, Tokyo	¥4,618,041 million	¥11,664,291 million

## II Matters Regarding Shares

From April 4, 2022, the Company transferred from the 1st Section to the Prime Market under the new market classification of the Tokyo Stock Exchange.

### 1. Total number of shares authorized to be issued by NTT

6,192,920,900 shares

### 2. Total number of shares issued and outstanding

3,622,012,656 shares

### 3. Number of shareholders as of the end of the fiscal year ended March 31, 2022

888,337 shareholders

#### Breakdown of Shares by Shareholder

The number of shares is rounded down to the nearest thousand. The figures in parentheses represent percentage of total shares owned for each category of shareholder.

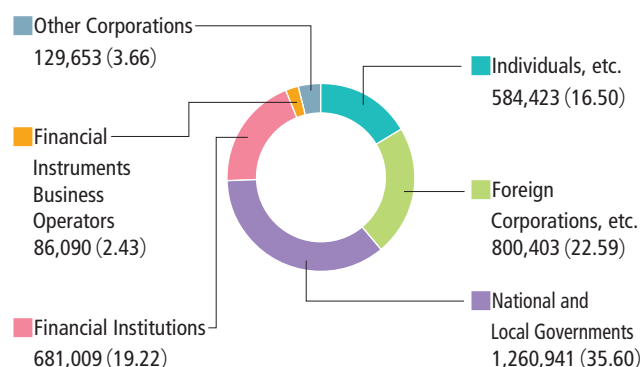

Notes: 1. The percentages represent the ratio of shareholders' shares to the total number of issued shares excluding treasury stock.

Treasury stock does not include shares of the Company held by the officer compensation BIP (Board Incentive Plan) trust.

2. Other Corporations above includes 57 thousand shares in the name of Japan Securities Depository Center.

### 4. Principal Shareholders

Shareholders	Number of Shares Held (thousands)	Equity Ownership (%)
The Minister of Finance	1,260,901	35.59
The Master Trust Bank of Japan, Ltd. (Trust Account)	368,424	10.40
Custody Bank of Japan, Ltd. (Trust Account)	159,421	4.50
Toyota Motor Corporation	80,775	2.28
Moxley & Co. LLC	35,674	1.01
Nippon Life Insurance Company	27,200	0.77
Barclays Securities Japan Ltd.	25,876	0.73
State Street Bank West Client – Treaty 505234	25,278	0.71
JPMorgan Chase Bank 385632	24,783	0.70
NTT Employee Share-Holding Association	24,740	0.70

Notes: 1. Number of Shares Held is rounded down to the nearest thousand.

2. NTT's holdings of treasury stock (79,490,430 shares) are not included in the above table.

3. Equity ownership percentages do not include treasury stock. Furthermore, treasury stock does not include 1,089,760 shares of the Company held by the officer compensation BIP trust.

# III Matters Regarding Corporate Governance

## 1. Fundamental Policies

We believe that strengthening the system of corporate governance in accordance with the purposes of each principle of the “Corporate Governance Code” of the Tokyo Stock Exchange is an important management issue for maximizing corporate value while meeting the expectations of various stakeholders, including shareholders and other investors, as well as customers, business partners, and employees. Therefore, we are working to strengthen corporate governance based on our fundamental policies of ensuring sound management, executing appropriate decision-making and business activities, clarifying accountability, and maintaining thorough compliance.

### Corporate Governance System

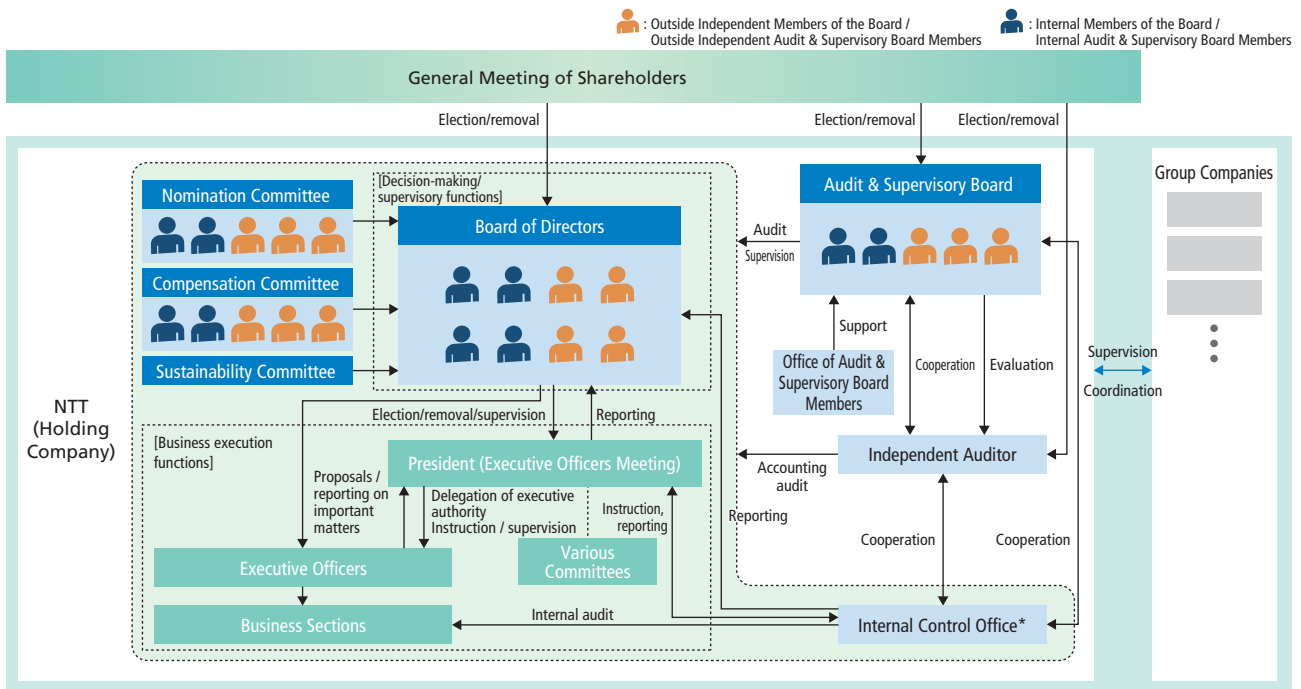

As of March 31, 2022

\*The Internal Control Office is scheduled to be renamed the Internal Audit Department on June 24, 2022.

## **2. Overview of Corporate Governance System**

---

NTT believes that an auditing system based on Audit & Supervisory Board Members, including outside independent Audit & Supervisory Board Members, is an effective means of supervising management. Accordingly, we chose the company with Board of Company Auditors (Audit & Supervisory Board) model. In addition, through the election of outside independent Members of the Board, NTT has strengthened the function of appropriately supervising the business execution.

## **3. Board of Directors**

---

The Board of Directors has eight Members of the Board, including four outside independent Members of the Board, which brings the total percentage of outside Members of the Board to 50%. In addition, the introduction of an executive officer system that clearly separates the management decision-making and oversight functions from the business execution function ensures closer supervision of execution and enhanced management flexibility. In principle, the ordinary meetings of the Board of Directors are held once per month, and extraordinary meetings are held as needed. The Board of Directors discusses the group management strategies and makes decisions on matters stipulated by laws and regulations and on important matters related to company management and group management. Moreover, through such means as periodic reports from Members of the Board and Executive Officers on the status of business execution, the Board of Directors supervises the business execution of Members of the Board and Executive Officers.

Each outside independent Member of the Board has extensive experience and a high level of integrity and insight. We believe that the outside independent Members of the Board will help strengthen the supervisory function for business execution and expect to incorporate the opinion they provide from their wide-ranging managerial perspective.

With the objective of further strengthening the independence, objectivity, and accountability in decisions with respect to appointments and compensation of officers, etc. made by the Board of Directors, the Company has voluntarily established a Nomination Committee and Compensation Committee, each consisting of five Members of the Board, of which a majority (three) are outside independent Members of the Board, as preliminary review institutions of the Board of Directors, thereby increasing the effectiveness of governance.

Moreover, in recognition of the fact that response to sustainability issues is an important management challenge, the Company has voluntarily established a Sustainability Committee that reports directly to the Board of Directors. The committee will work to further promote initiatives after important issues and indicators have been decided by resolution of the Board of Directors.

### **[Evaluation of the Effectiveness of the Board of Directors]**

The Board of Directors of the Company, which is a pure holding company, plays the role of monitoring the specific business operations of the Group companies based on the medium- to long-term business strategy of the entire Group.

The Board of Directors of the Company decides important items related to the Group's management that have passed the Executive Officers Meeting, which is made up of the Executive Officers and others, as well as the review of the various committees chaired by the President or a Senior Executive Vice President and attended by the relevant Executive Officers, while also monitoring the status of the execution of the duties of the individual Members of the Board and Executive Officers.

At meetings of the Board of Directors, based on the authority of the individual Members of the Board, current issues in group management and the initiatives being taken to resolve them are reported and reviewed, as well as initiatives for growing the business, such as investments and partnerships. During the fiscal year under review, active discussions were held centering on important matters related to company and group management, such as the promotion of sustainability, and the formulation of policies to further strengthen governance under the



Medium-Term Management Strategy “Your Value Partner 2025,” which was reviewed with a view toward future changes in the business environment. In the fiscal year under review, there was an increase in the proportion of agenda items related to management strategy in particular due to the refinement of the Medium-Term Management Strategy capturing social conditions such as the growing interest in sustainability and progress in the development of a remote and decentralized society as well as the review of the group management structure, including making NTT DOCOMO a wholly owned subsidiary. Furthermore, in addition to the advance explanations of agenda items to be discussed at Board of Directors meetings, explanations of matters such as issues of immediate concern and the status of considerations were also given to the outside independent Members of the Board by Representative Members of the Board. By striving to clarify the focus of execution of duties and the purpose of initiatives, we are creating an environment in which the supervisory function of the Board of Directors can be fully exercised.

Furthermore, to allow the outside independent Members of the Board to more deeply understand the Company’s business, meetings were held between the outside independent Members of the Board and Representative Members of the Board to exchange ideas and opinions on the Company’s management strategies, and they received explanations on topics such as the results of cutting-edge research at exhibitions of research and development where the Company is focusing its efforts. Additionally, ideas and opinions on issues in NTT Group management were exchanged among the outside independent Members of the Board, the Audit & Supervisory Board Members of the Company, and the outside independent Members of the Board of the major Group companies and other members.

At these meetings, we received evaluations on NTT’s Board of Directors from the outside independent Members of the Board and the Audit & Supervisory Board Members that adequate information is provided and Members of the Board engage in active discussions, thereby ensuring the Board’s effectiveness.

In addition, NTT implements an evaluation of the effectiveness of the Board of Directors annually for the purpose of strengthening the governance of the top management through continuous improvement of effectiveness of the Board of Directors. During the fiscal year under review also, NTT implemented an evaluation of its effectiveness as a Board of Directors, with the support of a third-party organization, getting all Members of the Board and Audit & Supervisory Board Members to complete a questionnaire survey concerning the Board of Directors. Questions were asked with regard to the role and responsibilities of the Board of Directors, its composition, its operation, and its satisfaction level. The results, which were compiled at the third-party organization, confirmed that the Board was sufficiently fulfilling its important role and responsibilities, with a majority of positive opinions for all of the questions.

In addition, as a result of the enhancement of governance-related issues, such as holding opinion-exchange meetings to stimulate strategic discussions, and enhancement of discussions on important issues such as sustainability, all members expressed positive opinions. Therefore, we have evaluated that the effectiveness of the Board of Directors is being ensured.

At the same time, regarding efforts to deepen understanding of items becoming more complex, while a certain degree of recognition was received, there were also some opinions that there is still room for improvement, so we will continue efforts to achieve improvements by aiming for more efficient operation of the Board of Directors through enhancing supplementary explanations related to the background of the deliberation items in advance explanations and further expanding opportunities for exchanging opinions with the executives of the major subsidiaries.

### Breakdown of Matters Discussed at the Meetings of the Board of Directors

#### Corporate Governance

42%

- General Meeting of Shareholders-related
- Evaluation of the effectiveness of internal control systems
- Operational status of internal whistleblowing system
- Human resources
- Policies to further strengthen governance Etc.

#### Capital Policy

9%

- Returns of shareholders (share buybacks and dividends)
- Financing and loans Etc.

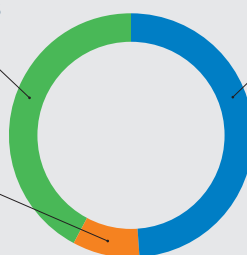

#### Management Strategy

49%

- NTT Group operations
- Review of NTT Group operational structure
- Global strategy
- M&A of operating companies
- Report on the status of execution of duties
- Approval of Annual Report and Financial Statements
- Research and development plans Etc.

## 4. Audit & Supervisory Board

The Audit & Supervisory Board consists of a total of five Audit & Supervisory Board Members: two internal Audit & Supervisory Board Members and three outside independent Audit & Supervisory Board Members (including two women, one in each category). Based on the audit plan for the fiscal year under review, and with business continuing to change significantly as a result of efforts to strengthen the competitiveness of global businesses and to integrate the functions of the new DOCOMO Group, in addition to audits in accordance with laws and regulations, Audit & Supervisory Board Members conducted audits on progress of the Medium-Term Management Strategy and the status of initiatives aimed at maintaining and improving corporate governance, endeavoring to conduct efficient and effective audits in cooperation with the Internal Control Office, the Independent Auditor, and the Audit & Supervisory Board Members of Group companies. Furthermore, by exchanging opinions with Representative Members of the Board and outside independent Members of the Board, and sharing views on various topics with Representative Members of the Board and Audit & Supervisory Board Members of Group companies, including overseas subsidiaries, not only do the Audit & Supervisory Board Members gain an understanding of the status of the performance of duties by Members of the Board and Executive Officers, but they are also in a position to offer suggestions as required. During the fiscal year under review, Audit & Supervisory Board Members exchanged opinions with Representative Members of the Board and outside independent Members of the Board a total of 43 times, and held meetings to exchange opinions with Representative Members of the Board and Audit & Supervisory Board Members of Group companies a total of 53 times.

In addition, the Audit & Supervisory Board Members, including outside independent Audit & Supervisory Board Members, attend important meetings, such as meetings of the Board of Directors, and conduct appropriate audits regarding the status of the business execution by Members of the Board and Executive Officers. They also take steps to strengthen audit cooperation by meeting periodically, or as required, with the Internal Control Office, Independent Auditor, and Audit & Supervisory Board Members of Group companies, with the aim of exchanging information on a timely basis. Further, in order to advance the Group's auditing system, Audit & Supervisory Board Members have unified risk recognition based on the materiality and risk approach with the Audit & Supervisory Board Members of major Group companies, and conducted audits and on-site inspections through the Audit & Supervisory Board Members of major Group companies.

Moreover, the effectiveness of the Audit & Supervisory Board has continued to be evaluated since FY2018 for the purpose of looking back at the audit activities of the current fiscal year, reflecting such evaluation in the audit plan for the following fiscal year and improving the quality of audits. When conducting the evaluation of effectiveness for the fiscal year under review, in addition to a questionnaire being given to each Audit & Supervisory Board Member, the three independent outside Audit & Supervisory Board Members were interviewed. To ensure anonymity and an objective viewpoint, a third-party organization was used to implement the questionnaire and interviews and to analyze the collected results. Furthermore, as the globalization of NTT Group progresses, the Audit & Supervisory Board has, from the viewpoint of incorporating a global perspective into its auditing, in addition to the conventional evaluation items that ask about changes over time, deepened the process of analysis and evaluation by referring to the practices of audit committees in the U.S. and U.K. companies, using them as a reference approach for questionnaire items and analysis. The primary items of evaluation for the fiscal year under review were as follows: the audit plan; advice to the management and audits of business execution; the Group's audit system; responses to acts in violation of rules, etc.; cooperation between the three audits (audit by the Audit & Supervisory Board, audit by the Independent Auditor, and audit by the internal audit division); operation of the Audit & Supervisory Board meetings, among other matters. As a result of discussion and inspection by Audit & Supervisory Board meeting based on the above, the effectiveness of the Audit & Supervisory Board was evaluated as being secured.

NTT will continue to strengthen cooperation between the various bodies such as the Internal Control Office, the Group companies' respective Audit & Supervisory Board Members and work to further develop the sophistication of the Group's audit system. In light of the increasing responsibility to meet social demands and the enhancement of non-financial information disclosure, we will further monitor the efforts of Members of the Board and Executive Officers and proactively provide advice to them. Also, we will work to further improve the effectiveness of the Audit & Supervisory Board by further strengthening cooperation with independent outside Members of the Board when conducting audits on executive management.

## 5. Nomination Committee and Compensation Committee

For the purpose of further enhancing independence, objectivity and accountability in the decisions of nominations and compensation of officers, etc. by the Board of Directors, NTT has voluntarily established the Nomination Committee and the Compensation Committee, which each consist of five Members of the Board (of which three members, a majority of committee members, are outside independent Members of the Board), as a preliminary review institution of the Board of Directors, and is increasing the effectiveness of governance. During the fiscal year under review, the number of outside independent Members of the Board was increased by one from August 6, 2021 to increase the independence of the committee composition. From November 10, 2021, the existing Appointment and Compensation Committee was separated and transitioned into the Nomination Committee and the Compensation Committee, according to their functions, further clarifying the authority and role of each committee. Membership of each committee consists of Jun Sawada (Representative Member of the Board, President), Akira Shimada (Representative Member of the Board, Senior Executive Vice President), Katsuhiko Shirai (outside Member of the Board), Sadayuki Sakakibara (outside Member of the Board), and Ken Sakamura (outside Member of the Board), with Jun Sawada (Representative Member of the Board, President) serving as chairman of each committee. Resolutions of each committee are made by a majority of such committee's members in attendance, at meetings in which a majority of committee members are present.

In the fiscal year under review, in addition to the Appointment and Compensation Committee meeting six times, Nomination Committee meeting twice, and Compensation Committee meeting once, committee members met to exchange opinions, engaging in active discussions on subjects such as revising the officer compensation system, the nomination of officers, etc., succession planning, and the response based on the revised Corporate Governance Code.

## 6. Nomination of Members of the Board, Etc.

In terms of the composition of the Company's Board of Directors, the nomination of executives is based on the NTT Group Personnel Policy, and personnel with the skills to resolve issues recognized by NTT Group are nominated broadly from inside and outside of the Group. Outside Members of the Board and outside Audit & Supervisory Board Members are elected with the expectation that they can provide opinions based on a broad management perspective or as an expert. Furthermore, both non-outside and outside Members of the Board are elected in line with NTT Group's promotion of diversity.

Moreover, due to the provisions of the law of Japan (Article 10, paragraph (1) of the Act on Nippon Telegraph and Telephone Corporation, etc.), a person who does not have Japanese nationality may not become a Member of the Board or Audit & Supervisory Board Member.

### NTT Group Personnel Policy

#### [Basic Policy]

NTT Group strives to contribute to the resolution of societal issues and the realization of a safer, more secure, and more affluent society. To accomplish this goal, the Group acts as a trusted "Your Value Partner" that customers continue to select in order to provide them with new value on a global basis. We have established the policy of positioning individuals that share these ideals in the upper ranks of NTT Group's management, and we are nominating such individuals from both inside and outside the Group.

#### [Nomination of Candidates for Members of the Board]

In regard to Member of the Board candidates, individuals are nominated based on the broad-ranging perspective and experience, superior management skill and leadership, business sense and motivation necessary to contribute to the overall development of NTT Group in order to facilitate the improvement in NTT Group's corporate value. The Board of Directors is of a size appropriate to the Group's business, and the composition of the Board of Directors takes into account a balance of specialties and diversity.

From the perspective of strengthening the function of supervising business execution, for outside independent Members of the Board, NTT nominates individuals who present no risk of a conflict of interest with general shareholders. In principle, NTT appoints several outside independent Members of the Board.

#### [Nomination of Candidates for Audit & Supervisory Board Members]

NTT has the policy of nominating candidates for Audit & Supervisory Board Members that have the capacity to provide audits based on specialized experience and insight.

From the perspective of guaranteeing fair audits of the execution of duties by Members of the Board, for outside independent Audit & Supervisory Board Members, NTT nominates individuals who present no risk of a conflict of interest with general shareholders. In accordance with the Companies Act, NTT ensures that outside Audit & Supervisory Board Members make up half or more of the Audit & Supervisory Board.

With regard to the nomination of Members of the Board, NTT has established the Nomination Committee, which consists of five Members of the Board including three outside independent Members of the Board. The committee discusses candidates and then makes proposals to be approved by the Board of Directors and presented for voting at the General Meeting of Shareholders. With regard to the nomination of candidates for Audit & Supervisory Board Members, the procedure for nomination involves Members of the Board proposing Audit & Supervisory Board Member candidates based on the nomination policy described above. These proposals are then discussed by the Audit & Supervisory Board, which consists of half or more of outside Audit & Supervisory Board Members, and consent is granted if appropriate. The candidates are then approved by the Board of Directors and presented for voting at the General Meeting of Shareholders.

### [Succession Plan]

With respect to successor candidates for the CEO position, we view it as important to secure successor candidates who can respond to technological innovation, market trends, and the speed of changes in the business environment. By securing the diversity of candidates through offering experience of a broad range of jobs and appointments to important posts, we are cultivating personnel for promotion who, in addition to possessing integrity and insight, are exceptionally well-suited to the times. The decision regarding the appointment is made by the Board of Directors after it has been presented for deliberation to the Nomination Committee, a preliminary review institution of the Board of Directors, which consists of five Members of the Board including three outside independent Members of the Board.

For future management candidates, we select various people of any age, gender, or field of expertise. Through education at the NTT University, which was started as a program for developing management candidates, we target diverse people who are full of desire to lead our transformation.

### [Independence of Outside Members of the Board and Outside Audit & Supervisory Board Members]

From the perspectives of strengthening the supervisory function for execution and guaranteeing appropriate audits of the execution of duties by Members of the Board, NTT has the policy of selecting individuals to serve as outside Members of the Board and outside Audit & Supervisory Board Members who do not represent risks of conflicts of interest with general shareholders. NTT designates outside Members of the Board and outside Audit & Supervisory Board Members who fulfill both the independence criteria stipulated by the Tokyo Stock Exchange and NTT's own independence standards as independent Members of the Board or independent Audit & Supervisory Board Members.

#### Independence Standards

**In order to meet the independence criteria, a person may not fall under any of the categories below in the last three fiscal years**

- (1) A person who executes business in a partner company that exceeds NTT's Standards\*<sup>1</sup>
  - (2) A person who executes business in a lending company that exceeds NTT's Standards\*<sup>2</sup>
  - (3) A consultant, accountant, lawyer, or any other person providing professional services, who received monetary payments or any other gain in assets equal to or more than ¥10 million, excluding the Board Members' or Audit & Supervisory Board Members' compensation, from NTT or its major subsidiaries\*<sup>3</sup> in any of the last three fiscal years
  - (4) A person who executes business in an organization that received donations exceeding NTT's Standards\*<sup>4</sup>
- Even if any of (1) through (4) above applies to a person, where it has been decided that a person meets the Independence Standards, the reasons shall be explained and disclosed at the time of the person's appointment as the independent Member of the Board or independent Audit & Supervisory Board Member.

\*<sup>1</sup> "A partner company that exceeds NTT's Standards" is defined as a company that has had any business dealing with NTT and its major subsidiaries\*<sup>3</sup> in any of the last three fiscal years equal to or more than 2% of the total operating revenues of NTT and its major subsidiaries for the respective fiscal year.

\*<sup>2</sup> "A lending company that exceeds NTT's Standards" is defined as a company in which the total amount of borrowings on a consolidated basis in any of the last three fiscal years equals to or is more than 2% of NTT's consolidated total assets for the respective fiscal year.

\*<sup>3</sup> The major subsidiaries are NTT DOCOMO, NTT East, NTT West, NTT Communications, and NTT DATA.

\*<sup>4</sup> "An organization that received donations exceeding NTT's Standards" is defined as an organization which received donations from NTT and its major subsidiaries\*<sup>3</sup> in any of the last three fiscal years exceeding ¥10 million or 2% of the total income of the organization, whichever is larger, during the respective fiscal year.

## 7. Training for Members of the Board and Audit & Supervisory Board Members

NTT Group works to cultivate candidates suitable for top management who are able to respond to the rapidly changing management environment, by creating a range of training opportunities in areas including domestic and overseas economic and social issues, compliance, and risk management, and by allowing employees to accumulate new job experiences. Additionally, outside independent Members of the Board can gain a deeper understanding of the Company's group businesses through opportunities to deepen their understanding of the business trends of NTT Group companies and of the latest R&D results at the research facilities of the Company.

## 8. Strategic Shareholdings

NTT does not hold shares for the purpose of creating stable shareholders, and has no plans to hold such shares in the future.

Conversely, NTT's business policy is to promote open innovation and collaboration with partners in a variety of industries with the aim of enhancing corporate value over the medium to long term. Based on this policy, the Company verifies whether an individual holding will contribute to medium- to long-term enhancements in corporate value and holds or sells shares accordingly. Among the comprehensive list of factors taken into consideration by the Investment Strategy Committee are the contribution to the medium- to long-term results of NTT, the progress of business collaborations, future considerations concerning business collaborations, trends in performance at investment targets and future business strategies of NTT. We apply the same policy to the strategic shareholdings of our Group companies, verifying every year whether individual holdings are appropriate, and taking steps to sell, etc. accordingly.

With respect to exercising voting rights of strategic shareholdings, NTT exercises voting rights acquired through share ownership, as it sees fit and appropriate and upon determining whether it is an initiative that would contribute to the improvement of medium- to long-term corporate value, from the perspective of sustainable growth of the companies NTT invests in and improving corporate value for both NTT and the companies.

The total balance sheet amount and the ratio to total equity as of March 31, 2022 are as follows.

① Total equity (consolidated)	¥9,018,132 million
② Total balance sheet amount	¥754,501 million
③ Ratio (②÷①)	8.4%

(Note) ② Total balance sheet amount is the sum of the top two largest amounts stated by the Company and its consolidated subsidiaries (the Company and NTT DOCOMO) in their Annual Securities Reports, as stipulated by the Cabinet Office Order on Disclosure of Corporate Affairs.

## 9. Capital Policy

With regard to dividends, our basic policy is to steadily increase dividends, and we also flexibly carry out buybacks to improve capital efficiency.

## IV Matters Regarding Corporate Officers

### 1. Status of Members of the Board and Audit & Supervisory Board Members

Name		Position and Responsibilities	Number of Shares of the Company Held
<b>Hiromichi Shinohara</b>		Chairman of the Board	53,400 shares
<b>Jun Sawada</b>		Representative Member of the Board President and Chief Executive Officer (CEO)	41,500 shares
<b>Akira Shimada</b>		Representative Member of the Board Senior Executive Vice President In charge of business strategy Chief Financial Officer (CFO) Chief Compliance Officer (CCO) Chief Human Resource Officer (CHRO)	26,808 shares
<b>Naoki Shibutani</b>		Representative Member of the Board Senior Executive Vice President In charge of technical strategy Chief Technology Officer (CTO) Chief Information Officer (CIO) Chief Digital Officer (CDO)	13,500 shares
<b>Katsuhiko Shirai</b>	Outside Independent	Member of the Board	11,900 shares
<b>Sadayuki Sakakibara</b>	Outside Independent	Member of the Board	23,000 shares
<b>Ken Sakamura</b>	Outside Independent	Member of the Board	1,700 shares
<b>Keiko Takegawa</b>	Outside Independent	Member of the Board	2,200 shares
<b>Takao Maezawa</b>		Full-time Audit & Supervisory Board Member	20,808 shares
<b>Kanae Takahashi</b>		Full-time Audit & Supervisory Board Member	6,500 shares
<b>Takashi Iida</b>	Outside Independent	Audit & Supervisory Board Member	7,700 shares
<b>Hideki Kanda</b>	Outside Independent	Audit & Supervisory Board Member	0 shares
<b>Kaoru Kashima</b>	Outside Independent	Audit & Supervisory Board Member	0 shares

- Notes: 1. Of the 13 Members of the Board and Audit & Supervisory Board Members, ten are male and three are female.  
2. Of the Members of the Board, Mr. Katsuhiko Shirai, Mr. Sadayuki Sakakibara, Mr. Ken Sakamura and Ms. Keiko Takegawa are outside Members of the Board as defined in Article 2, paragraph (15) of the Companies Act. Also, based on the listing rules of the Tokyo Stock Exchange, NTT has designated them as independent Members of the Board and filed the information related thereto with the Tokyo Stock Exchange.  
3. Of the Audit & Supervisory Board Members, Mr. Takashi Iida, Mr. Hideki Kanda and Ms. Kaoru Kashima are outside Audit & Supervisory Board Members as defined in Article 2, paragraph (16) of the Companies Act. Also, based on the listing rules of the Tokyo Stock Exchange, NTT has designated them as independent Audit & Supervisory Board Members and filed the information related thereto with the Tokyo Stock Exchange.

Term of Office	Attendance Rate		Description of Principal Concurrent Positions
	Board of Directors Meetings	Audit & Supervisory Board Meetings	
13 years	15/15 (100%)	—	Outside Director of Yamaha Corporation (Assumed on June 24, 2021)
8 years	15/15 (100%)	—	President and Chief Executive Officer of NTT, Inc.
10 years	15/15 (100%)	—	Senior Executive Vice President of NTT, Inc.
2 years	15/15 (100%)	—	
10 years	15/15 (100%)	—	
10 years	15/15 (100%)	—	Outside Director of SHIMANO INC. Outside Director of Nitori Holdings Co., Ltd. Chairman of the Board of The Kansai Electric Power Co., Inc.
3 years	15/15 (100%)	—	Professor of Toyo University
3 years	14/15 (93%)	—	Specially Appointed Professor of Showa Women's University (Assumed on April 1, 2021) Outside Director of the Board of Sekisui House, Ltd. (Assumed on April 27, 2021) Outside Director of MITSUI MINING & SMELTING CO., LTD. (Assumed on June 29, 2021) [Outside Auditor of MITSUI MINING & SMELTING CO., LTD. (Retired on June 29, 2021)]
6 years	15/15 (100%)	26/26 (100%)	Audit & Supervisory Board Member of NTT, Inc.
2 years	15/15 (100%)	26/26 (100%)	Audit & Supervisory Board Member of NTT, Inc.
8 years	15/15 (100%)	26/26 (100%)	Lawyer Outside Director of ALPS ALPINE CO., LTD.
3 years	15/15 (100%)	26/26 (100%)	Professor of Professional School of Gakushuin University External Director of Sumitomo Mitsui Trust Bank, Limited
3 years	14/15 (93%)	26/26 (100%)	Certified Public Accountant Audit & Supervisory Board Member of Kirin Holdings Company, Limited External Director of Sumitomo Mitsui Trust Holdings, Inc. (Assumed on June 23, 2021) [External Director of Sumitomo Mitsui Trust Bank, Limited (Retired on June 23, 2021)]

- Audit & Supervisory Board Member Takao Maezawa has business experience in the accounting division of NTT and its related companies, and Audit & Supervisory Board Member Kaoru Kashima is a certified public accountant. Both individuals have extensive knowledge of finance and accounting matters.
- There is no special relationship between NTT and the companies where outside Members of the Board and outside Audit & Supervisory Board Members hold concurrent positions.
- Even in circumstances where outside Members of the Board and outside Audit & Supervisory Board Members were unable to attend a meeting, they were provided with an explanation in advance and they submitted their opinions.

## 2. Directors and Officers Liability Insurance Policy

---

NTT has entered into a directors and officers liability insurance policy as provided for in Article 430-3, paragraph (1) of the Companies Act with an insurance company. This insurance policy covers the insured's losses and such costs as related litigation expenses incurred from claims for damages arising from acts (including nonfeasance) carried out by the insured as an officer or a person at a certain position of the Company. However, losses and costs personally incurred by the insured due to criminal acts, such as bribery, and intentional illegal activities are not covered by the policy as a measure to ensure that the proper performance of duties by officers is not impaired.

The insureds included in this policy consist of the Members of the Board, Audit & Supervisory Board Members and Executive Officers of NTT and NTT subsidiaries NTT East, NTT West, NTT Inc.

## 3. Policies Concerning, and Total Compensation, etc. of Members of the Board and Audit & Supervisory Board Members

---

The Board of Directors resolved at its meeting held on May 12, 2021 a new policy for determining the details of individual compensation, etc. for Members of the Board (hereinafter "Determination Policy"; this was partially amended by resolution of the Board of Directors at a meeting held on November 10, 2021). The overview of the Determination Policy is as follows.

Concerning the Determination Policy, composition and level of compensation for Members of the Board of NTT, in order to secure objectivity and transparency, NTT established the Compensation Committee, comprised of five Members of the Board, including three outside independent Members of the Board. Compensation matters are decided by the Board of Directors after deliberation by this committee. Moreover, decisions on the composition ratios and calculation methods for compensation, and individual amounts of compensation for each Member of the Board are delegated from the Board of Directors to the Compensation Committee. The reason for delegating these authorities to the Compensation Committee is that said committee is composed of two Representative Members of the Board and three outside Members of the Board, and we believe that it is able to make the appropriate judgements from an outside perspective while also taking a bird's-eye view of the Company's overall performance.

Compensation of Members of the Board (excluding outside Members of the Board) consists of a monthly salary (base salary) and a bonus (compensation related to performance over the short term), NTT stock purchase through Board Members Shareholding Association and stock compensation (compensation related to performance over the medium to long term).

The base salary is a fixed compensation paid monthly on the basis of the scope of each Member of the Board's roles and responsibilities. The bonus is paid in June each year, taking into account NTT's business results for the current fiscal year. The financial targets of the Medium-Term Management Strategy have been selected as performance indicators for bonus. This is because greater clarification of the link between Members of the Board's compensation and the Company's corporate value increases the motivation to achieve the financial targets in the Medium-Term Management Strategy. In addition, the method for calculating bonus is to convert the level of year-on-year improvement or achievement level of the plan for each financial target into a payment rate with a predetermined method for each indicator, weighting the average based on the weight of each indicator then multiplying the base salary by position. (Please refer to "Bonus Performance Indicators" on the next page.)

Also, Members of the Board make contributions of a certain defined amount or more every month for the purchase of NTT shares through the Board Members Shareholding Association in order to reflect NTT's medium-to long-term business results in compensation. Purchased shares are to be held by the Members of the Board throughout their terms of office.

For the stock compensation, a trust, established by NTT is used. The Members of the Board are granted points corresponding to their role in June each year and a performance-related coefficient corresponding to the level of achievement of the performance indicator is determined in June of the year following the final fiscal year of the Medium-Term Management Strategy, and the number of shares to be granted to each Member of the Board is calculated by multiplying the performance-related coefficient by the number of points that has been accumulated. The granted shares are delivered to the Member of the Board upon retirement.

EPS has been selected as a performance indicator for stock compensation because it is the main financial target



in the Medium-Term Management Strategy.

The composition ratio of compensation in a case where standard business results are achieved is roughly as follows: Fixed compensation: Short-term performance-related compensation: Medium- to long-term performance-related compensation = 50%: 30%: 20%.

In order to maintain a high level of independence, compensation of outside Members of the Board consists of a monthly fixed compensation only, and is not linked to NTT's business results.

Note that an overview of the policy for determining the details of individual compensation, etc. of Members of the Board is as provided above, and when determining the details of the individual compensation, etc. of Members of the Board, the Compensation Committee considers matters from various angles, including consistency with the Determination Policy, so, the Board of Directors respects its judgment, and the details of the individual compensation, etc. of Members of the Board for the fiscal year under review are judged to be in line with the Determination Policy.

Compensation of Audit & Supervisory Board Members is determined by resolution of the Audit & Supervisory Board and consists of a base salary only, for the same reasons as those cited above with respect to outside Members of the Board.

In the fiscal year under review, the membership of the Compensation Committee consists of Jun Sawada (Representative Member of the Board, President), Akira Shimada (Representative Member of the Board, Senior Executive Vice President), Katsuhiko Shirai (outside Member of the Board), Sadayuki Sakakibara (outside Member of the Board), and Ken Sakamura (outside Member of the Board).

### Bonus Performance Indicators

Financial targets of the Medium-Term Management Strategy and other measures are set as performance indicators and the level of year-on-year improvement or achievement level of the plan are evaluated.

Performance Indicators*	Evaluation Weighting	Evaluation Method	FY2020 Results	FY2021 Results
EPS	35%	YoY improvement	¥248	¥329

Performance Indicators*	Evaluation Weighting	Evaluation Method	FY2021 Targets	FY2021 Results
Operating profit	35%	Achievement level of plan	¥1,730.0 billion	¥1,768.6 billion
ROIC	9%		7.4%	7.5%
Capex to Sales	6%		13.5%	13.1%
Overseas sales	6%		\$19,000 million	\$18,878 million
Overseas operating profit margin	6%		6.0%	6.3%

\*In addition to the above performance indicators, the level of achievement of the plan target for the number of B2B2X projects was evaluated.

In light of the establishment of the new NTT Group Sustainability Charter on November 10, 2021, we plan to make changes to the bonus performance indicators in FY2022 and beyond, including the addition of three new sustainability indicators, with the aim of embodying the three themes in a sustainable society.

Category	Performance Indicators	Evaluation Weighting	Evaluation Method
Financial indicators	EPS	35%	Achievement level of plan
	Operating profit	35%	
	Overseas operating profit margin	10%	
	ROIC	5%	
Sustainability indicators	Greenhouse gas emissions	5%	
	B2B2X revenues	5%	
	Ratio of women newly promoted to management positions	5%	

## Total Compensation, etc. during the Fiscal Year Ended March 31, 2022

Position	Number of Persons	Base Salary (Millions of yen)	Bonuses (Millions of yen)	Stock compensation	Total Compensation (Millions of yen)
Members of the Board	8	279	130	37	446
Audit & Supervisory Board Members	5	138	—	—	138
Total (Of which outside Officers)	13 (7)	417 (121)	130 (—)	37 (—)	584 (121)

- Notes: 1. At the 21st Ordinary General Meeting of Shareholders held on June 28, 2006, the amount of compensation for Members of the Board was resolved to be ¥750 million or less annually. However, at the 36th Ordinary General Meeting of Shareholders held on June 24, 2021, it was resolved to change this into three components: (1) the amount of monetary compensation: ¥600 million or less annually, (2) the amount paid to Members of the Board as funds to acquire NTT's shares through the Board Members Shareholding Association: ¥50 million or less annually, and (3) the amount to be contributed for the performance-related stock compensation system: ¥100 million or less annually. Note that at the conclusion of this General Meeting of Shareholders, there were eight Members of the Board.
2. The amount of base salary for Members of the Board in the above includes ¥18 million paid as funds for acquisition of NTT's shares through the Board Members Shareholding Association.
3. The amount of compensation for Audit & Supervisory Board Members was resolved to be ¥200 million or less annually at the 21st Ordinary General Meeting of Shareholders held on June 28, 2006. Note that at the conclusion of this General Meeting of Shareholders, there were five Audit & Supervisory Board Members.
4. The amount of stock compensation shown above is the amount recorded as expenses for point grants for the fiscal year under review.

The Determination Policy at the end of the fiscal year under review is as stated above. An overview of the determination policy prior to the Board of Directors resolving the new Determination Policy at a meeting held on May 12, 2021, is provided below.

Compensation of Members of the Board (excluding outside Members of the Board) consists of a base salary and bonuses. The base salary is paid on the basis of the scope of each Member of the Board's roles and responsibilities. The bonus is paid based on consideration of the level of achievement of performance indicators. The financial targets of the Medium-Term Management Strategy have been selected as performance indicators. This is because greater clarification of the link between Members of the Board's compensation and the Company's corporate value increases the motivation to achieve the financial targets in the Medium-Term Management Strategy. In addition, the method for calculating bonuses is to convert the level of year on year improvement or achievement level of the plan for each financial target into a payment rate with a pre-determined method for each indicator, weighting the average based on the weight of each indicator then multiplying the base salary by position by a fixed number.

(Please refer to "Bonus Performance Indicators" on the previous page.)

Furthermore, Members of the Board make contributions of a certain defined amount or more from their base salary and bonus for the purchase of NTT shares through the Board Members Shareholding Association in order to reflect NTT's medium- to long-term business results in compensation. Purchased shares are to be held by the Members of the Board throughout their terms of office. The composition ratio of compensation in a case where standard business results are achieved is roughly as follows: Fixed compensation: Performance-related compensation = 70%: 30%.

In order to maintain a high level of independence, compensation of outside Members of the Board consists of a monthly base salary only, and is not linked to NTT's business results.

Note that for the specific particulars of the individual compensation, etc. of Members of the Board, this is determined by the Appointment and Compensation Committee in accordance with the determination policy resolved at the Board of Directors. The details of the authority entrusted to the Appointment and Compensation Committee by the Board of Directors are the determination of the proportion of compensation, method of calculation and the amount of compensation for each individual. These have been entrusted to the Appointment and Compensation Committee because this Committee comprises two Representative Members of the Board and two outside Members of the Board (Jun Sawada (Representative Member of the Board, President), Akira Shimada (Representative Member of the Board, Senior Executive Vice President), Katsuhiko Shirai (outside Member of the Board) and Sadayuki Sakakibara (outside Member of the Board)), and we believe that it is able to make the appropriate judgements from an outside perspective while also taking a bird's-eye view of the Company's overall performance. The above is an overview of the policy for determining the details of individual compensation, etc. of Members of the Board prior to May 12, 2021. When determining the details of the individual compensation, etc. of Members of the Board for the period from April 1 to June 30 of the same year, the Appointment and Compensation Committee (at that time) considered matters from various angles, including consistency with the determination policy, so, the Board of Directors respects its judgment, and the details of the individual compensation, etc. of Members of the Board for the period are judged to be in line with the determination policy.

Compensation of Audit & Supervisory Board Members is determined by resolution of the Audit & Supervisory Board and consists of a base salary only, for the same reasons as those cited above with respect to outside Members of the Board.

## 4. Outside Members of the Board and Outside Audit & Supervisory Board Members

### Principal Activities of Outside Members of the Board and Audit & Supervisory Board Members

Position	Name	Statements Made at Board of Directors' Meetings and Overview of Duties in Relation to the Role Expected to be Fulfilled by Outside Members of the Board
Outside Members of the Board	Katsuhiko Shirai	<p>Mr. Katsuhiko Shirai has a wealth of experience as an operational director of educational institutions, and has a high level of integrity and insight. He was therefore elected at the Ordinary General Meeting of Shareholders held in June 2020 on the expectation that he would help strengthen the supervisory function for business execution and provide advice from his wide-ranging perspectives on management, and he has been serving as outside Member of the Board.</p> <p>Mr. Shirai has made comments at meetings of the Board of Directors and meetings held to exchange opinions with Representative Members of the Board, mainly on subjects such as the impact of the Company's business on society, global strategy, advanced technology, and the promotion of sustainability (compliance and so on). In addition, on the Nomination Committee and the Compensation Committee he has offered advice on the appointment of officers, etc., succession planning, revising the officer compensation system, and the response based on the revised Corporate Governance Code.</p>
	Sadayuki Sakakibara	<p>Mr. Sadayuki Sakakibara has a wealth of experience as a corporate manager, and has a high level of integrity and insight. He was therefore elected at the Ordinary General Meeting of Shareholders held in June 2020 on the expectation that he would help strengthen the supervisory function for business execution and provide advice from his wide-ranging perspectives on management, and he has been serving as outside Member of the Board.</p> <p>Mr. Sakakibara has made comments at meetings of the Board of Directors and meetings held to exchange opinions with Representative Members of the Board, mainly on subjects such as Group management, capital policy, and the promotion of sustainability (corporate governance, compliance and so on). In addition, on the Nomination Committee and the Compensation Committee he has offered advice on the appointment of officers, etc., succession planning, revising the officer compensation system, and the response based on the revised Corporate Governance Code.</p>
	Ken Sakamura	<p>Mr. Ken Sakamura has a wealth of experience as an operational director of research institutions, including universities, and has a high level of integrity and insight. He was therefore elected at the Ordinary General Meeting of Shareholders held in June 2020 on the expectation that he would help strengthen the supervisory function for business execution and provide advice from his wide-ranging perspectives, and he has been serving as outside Member of the Board.</p> <p>Mr. Sakamura has made comments at meetings of the Board of Directors and meetings held to exchange opinions with Representative Members of the Board, mainly on subjects such as advanced technology, research and development, and the promotion of sustainability (compliance and so on). In addition, on the Nomination Committee and the Compensation Committee he has offered advice on the appointment of officers, etc., succession planning, revising the officer compensation system, and the response based on the revised Corporate Governance Code.</p>
	Keiko Takegawa	<p>Ms. Keiko Takegawa has a wealth of experience in public relations and diversity promotion within the government and has a high level of integrity and insight. She was therefore elected at the Ordinary General Meeting of Shareholders held in June 2020 on the expectation that she would help strengthen the supervisory function for business execution and provide advice from her wide-ranging perspectives, and she has been serving as outside Member of the Board.</p> <p>Ms. Takegawa has made comments at meetings of the Board of Directors and meetings held to exchange opinions with Representative Members of the Board, mainly on subjects such as public relations strategy and the promotion of sustainability (compliance and so on), as well as actively offering advice on promoting diversity, such as through encouraging the active participation of women.</p>

Position	Name	Statements Made at Board of Directors Meetings and Audit & Supervisory Board Meetings
Outside Audit & Supervisory Board Members	Takashi Iida	<p>Based on the professional perspective fostered through his extensive experience as a lawyer, Mr. Takashi Iida has made comments as necessary at meetings of the Board of Directors and the Audit &amp; Supervisory Board, at meetings held to exchange opinions with Representative Members of the Board and outside independent Members of the Board, and at meetings held to exchange opinions with Representative Members of the Board and Audit &amp; Supervisory Board Members of Group companies. These comments were mainly from a perspective of promoting sustainability, on subjects such as corporate governance and compliance. In addition, he actively provided advice on appropriate operation of internal rules.</p>
	Hideki Kanda	<p>Based on the professional perspective fostered through his extensive experience as a university professor, Mr. Hideki Kanda has made comments as necessary at meetings of the Board of Directors and the Audit &amp; Supervisory Board, at meetings held to exchange opinions with Representative Members of the Board and outside independent Members of the Board, and at meetings held to exchange opinions with Representative Members of the Board and Audit &amp; Supervisory Board Members of Group companies. These comments were mainly from a perspective of promoting sustainability, on subjects such as corporate governance and compliance. In addition to the above, he has actively provided advice and information, from such perspectives as the Companies Act and Corporate Governance Code, that contribute to the proper execution of business by the organizations of NTT Group.</p>
	Kaoru Kashima	<p>Based on the professional perspective fostered through her extensive experience as a certified public accountant, Ms. Kaoru Kashima has made comments as necessary at meetings of the Board of Directors and the Audit &amp; Supervisory Board, at meetings held to exchange opinions with Representative Members of the Board and outside independent Members of the Board, and at meetings held to exchange opinions with Representative Members of the Board and Audit &amp; Supervisory Board Members of Group companies. These comments mainly concerned subjects such as accounting audits, and from a perspective of promoting sustainability, on subjects such as corporate governance, compliance and promoting diversity. In addition to the above, at meetings held to exchange opinions with the Independent Auditor, and elsewhere, she has actively provided advice that contributes to higher quality of accounting audits.</p>

# Consolidated Financial Statements

## Consolidated Statement of Financial Position (March 31, 2022)

(Millions of yen)

Item	Amount	Item	Amount
<b>ASSETS</b>		<b>LIABILITIES AND EQUITY</b>	
<b>Current assets</b>		<b>Current liabilities</b>	
Cash and cash equivalents	834,564	Short-term borrowings	1,646,806
Trade and other receivables	3,604,959	Trade and other payables	2,500,341
Other financial assets	88,441	Lease liabilities	189,495
Inventories	408,362	Other financial liabilities	29,566
Other current assets	574,922	Accrued payroll	544,455
<b>Sub Total</b>	<b>5,511,248</b>	Income taxes payables	210,964
Assets held for sale	205,344	Other current liabilities	1,129,851
<b>Total current assets</b>	<b>5,716,592</b>	<b>Sub Total</b>	<b>6,251,478</b>
<b>Non-current assets</b>		Liabilities directly associated with assets held for sale	7,161
Property, plant and equipment	9,326,888	<b>Total current liabilities</b>	<b>6,258,639</b>
Right-of-use asset	694,612	<b>Non-current liabilities</b>	
Goodwill	1,213,009	Long-term borrowings	5,717,465
Intangible assets	1,951,824	Lease liabilities	655,729
Investment property	1,236,490	Other financial liabilities	135,686
Investments accounted for using the equity method	429,806	Defined benefit liabilities	1,561,049
Other financial assets	1,426,157	Deferred tax liabilities	137,474
Deferred tax assets	970,432	Other non-current liabilities	378,067
Other non-current assets	896,431	<b>Total non-current liabilities</b>	<b>8,585,470</b>
<b>Total non-current assets</b>	<b>18,145,649</b>	<b>Total liabilities</b>	<b>14,844,109</b>
		<b>Equity</b>	
		Nippon Telegraph and Telephone Corporation ("NTT") shareholders' equity	
		Common stock	937,950
		Retained earnings	7,293,915
		Treasury stock	(226,459)
		Other components of equity	277,050
		<b>Total NTT shareholders' equity</b>	<b>8,282,456</b>
		<b>Non-controlling interests</b>	<b>735,676</b>
		<b>Total equity</b>	<b>9,018,132</b>
<b>Total assets</b>	<b>23,862,241</b>	<b>Total liabilities and equity</b>	<b>23,862,241</b>

Note: Amounts are rounded to the nearest million yen.

## Consolidated Statement of Profit or Loss (Fiscal Year Ended March 31, 2022)

(Millions of yen)

Item	Amount	
<b>Operating revenues</b>		<b>12,156,447</b>
<b>Operating expenses</b>		
Personnel expenses	2,566,127	
Expenses for purchase of goods and services and other expenses	5,839,441	
Depreciation and amortization	1,561,183	
Loss on disposal of property, plant and equipment and intangible assets	132,073	
Impairment losses		
Goodwill	228	
Other	37,824	
Taxes and dues	250,978	<b>10,387,854</b>
<b>Operating profit</b>		<b>1,768,593</b>
<b>Finance income</b>		<b>63,471</b>
<b>Finance costs</b>		<b>56,250</b>
<b>Share of profit (loss) of entities accounted for using the equity method</b>		<b>19,711</b>
<b>Profit before taxes</b>		<b>1,795,525</b>
<b>Income taxes</b>		<b>539,531</b>
<b>Profit</b>		<b>1,255,994</b>
Profit attributable to NTT		1,181,083
Profit attributable to Non-controlling interests		74,911

Note: Amounts are rounded to the nearest million yen.

# Non-consolidated Financial Statements

## Non-consolidated Balance Sheet (March 31, 2022)

(Millions of yen)

Item	Amount	Item	Amount
<b>ASSETS</b>		<b>LIABILITIES</b>	
<b>Current assets</b>		<b>Current liabilities</b>	
Cash and bank deposits	405	Accounts payable, trade	494
Accounts receivable, trade	895	Current portion of corporate bonds	99,995
Supplies	201	Current portion of long-term borrowings	200,600
Advance payment	2,164	Current portion of long-term borrowings from subsidiaries	209,150
Short-term loans receivable	213,600	Short-term borrowings	1,891,730
Accounts receivable, other	280,207	Lease obligations	3
Other	4,974	Accounts payable, other	77,884
<b>Total current assets</b>	<b>502,446</b>	Accrued expenses	7,066
<b>Fixed assets</b>		Accrued taxes on income	61,027
<b>Property, plant and equipment</b>		Advances received	690
Buildings	71,031	Deposits received	304
Structures	5,218	Other	1,590
Machinery, equipment and vehicles	263	<b>Total current liabilities</b>	<b>2,550,532</b>
Tools, furniture and fixtures	24,845	<b>Long-term liabilities</b>	
Land	27,746	Long-term borrowings	333,874
Lease assets	10	Long-term borrowings from subsidiaries	3,700,730
Construction in progress	1,255	Lease obligations	8
<b>Total property, plant and equipment</b>	<b>130,369</b>	Deferred tax liabilities	24,395
<b>Intangible fixed assets</b>		Liability for employees' retirement benefits	35,511
Software	13,745	Asset retirement obligations	1,822
Other	394	Other	5,253
<b>Total intangible fixed assets</b>	<b>14,140</b>	<b>Total long-term liabilities</b>	<b>4,101,593</b>
<b>Investments and other assets</b>		<b>Total liabilities</b>	<b>6,652,125</b>
Investment securities	549,295	<b>NET ASSETS</b>	
Investments in subsidiaries and affiliated companies	9,964,727	<b>Shareholders' equity</b>	
Other securities of subsidiaries and affiliated companies	19,455	<b>Common stock</b>	<b>937,950</b>
Contributions to affiliated companies	4,097	<b>Capital surplus</b>	
Long-term loans receivable to subsidiaries	473,000	Additional paid-in capital	2,672,826
Prepaid pension costs	2,083	<b>Total capital surplus</b>	<b>2,672,826</b>
Other	4,680	<b>Earned surplus</b>	
<b>Total investments and other assets</b>	<b>11,017,337</b>	Legal reserve	135,333
<b>Total fixed assets</b>	<b>11,161,845</b>	Other earned surplus	
		Accumulated earned surplus	1,375,592
		<b>Total earned surplus</b>	<b>1,510,925</b>
		<b>Treasury stock</b>	<b>(226,459)</b>
		<b>Total shareholders' equity</b>	<b>4,895,242</b>
		Unrealized gains (losses), translation adjustments, and others	
		<b>Net unrealized gains (losses) on securities</b>	<b>116,923</b>
		Total unrealized gains (losses), translation adjustments, and others	116,923
		<b>Total net assets</b>	<b>5,012,166</b>
<b>Total assets</b>	<b>11,664,291</b>	<b>Total liabilities and net assets</b>	<b>11,664,291</b>

Note: Amounts are rounded to the nearest million yen.

## Non-consolidated Statement of Income (Fiscal Year Ended March 31, 2022)

(Millions of yen)

Item	Amount	
<b>Operating revenues</b>		
Dividends received	487,356	
Revenues from group management	25,400	
Revenues from basic R&D	122,000	
Other services	15,360	650,116
<b>Operating expenses</b>		
Administration	29,547	
Experiment and research	116,312	
Depreciation and amortization	19,513	
Retirement of fixed assets	1,002	
Miscellaneous taxes	3,936	170,310
<b>Operating income</b>		<b>479,806</b>
<b>Non-operating revenues</b>		
Interest income	2,512	
Gain on sale of investments in subsidiaries and affiliated companies	4,000	
Foreign exchange gains	5,156	
Lease and rental income	11,809	
Miscellaneous income	1,188	24,666
<b>Non-operating expenses</b>		
Interest expenses	18,467	
Corporate bond interest expenses	1,026	
Lease and rental expenses	8,002	
Miscellaneous expenses	2,481	29,974
<b>Recurring profit</b>		<b>474,497</b>
<b>Extraordinary losses</b>		
<b>Impairment losses</b>	<b>6,312</b>	<b>6,312</b>
<b>Income before income taxes</b>		<b>468,185</b>
<b>Corporation, inhabitant, and enterprise taxes</b>	<b>2,446</b>	
<b>Deferred tax expenses (benefits)</b>	<b>(4,763)</b>	<b>(2,317)</b>
<b>Net income</b>		<b>470,502</b>

Note: Amounts are rounded to the nearest million yen.

## Auditor's Report on Consolidated Financial Statements

### Independent Auditor's Report

To the Board of Directors of Nippon Telegraph and Telephone Corporation:

#### **Opinion**

We have audited the consolidated financial statements, which comprise the consolidated statement of financial position, the consolidated statement of profit or loss, the consolidated statement of changes in equity and the related notes to the consolidated financial statements of Nippon Telegraph and Telephone Corporation ("the Company") and its consolidated subsidiaries (collectively referred to as "the Group"), as at March 31, 2022 and for the year from April 1, 2021 to March 31, 2022 in accordance with Article 444-4 of the Companies Act.

In our opinion, the consolidated financial statements referred to above present fairly, in all material respects, the consolidated financial position and the results of operations of the Group for the period, for which the consolidated financial statements were prepared, in accordance with the latter part of Article 120-1 of the Ordinance of Companies Accounting that prescribes some omissions of disclosure items required by International Financial Reporting Standards.

#### **Basis for Opinion**

We conducted our audit in accordance with auditing standards generally accepted in Japan. Our responsibilities under those standards are further described in the *Auditor's Responsibilities for the Audit of the Consolidated Financial Statements* section of our report. We are independent of the Group in accordance with the ethical requirements that are relevant to our audit of the consolidated financial statements in Japan, and we have fulfilled our other ethical responsibilities in accordance with these requirements. We believe that the audit evidence we have obtained is sufficient and appropriate to provide a basis for our opinion.

#### **Emphasis of Matter**

We draw attention to Note "Realignment of the Global Business" under "Subsequent Events" in the related notes to the consolidated financial statements. The Company has resolved at the Board of Directors meeting held on May 9, 2022, that it will realign NTT group's global business (the "Realignment") by grouping the global businesses operated under NTT, Inc. and NTT Lmt. with the global business operated by NTT DATA Corporation ("NTT DATA") group, and has executed with NTT DATA a master agreement regarding the Realignment and shareholders' agreement.

Based upon the resolution at the Board of Directors meeting held on May 9, 2022, the Company will acquire shares of NTT DATA up to 60 million shares or 100 billion yen through market transactions.

Our opinion is not modified in respect of this matter.

#### **Other Information**

The other information comprises the business report and its supplementary schedules. Management is responsible for the preparation and presentation of the other information. Audit and supervisory board members and the audit and supervisory board are responsible for overseeing the directors' performance of their duties with regard to the design, implementation and maintenance of the reporting process for the other information.

Our opinion on the consolidated financial statements does not cover the other information and we do not express any form of assurance conclusion thereon.

In connection with our audit of the consolidated financial statements, our responsibility is to read the other information and, in doing so, consider whether the other information is materially inconsistent with the consolidated financial statements or our knowledge obtained in the audit, or otherwise appears to be materially misstated.

If, based on the work we have performed, we conclude that there is a material misstatement of this other information, we are required to report that fact.

We have nothing to report in this regard.

#### **Responsibilities of Management, Audit and Supervisory Board Members and Audit and Supervisory Board for the Consolidated Financial Statements**

Management is responsible for the preparation and fair presentation of the consolidated financial statements in accordance with the latter part of Article 120-1 of the Ordinance of Companies Accounting that prescribes some omissions of disclosure items required by International Financial Reporting Standards, and for such internal control as management determines is necessary to enable the preparation of consolidated financial statements that are free from material misstatement, whether due to fraud or error.

In preparing the consolidated financial statements, management is responsible for assessing the Group's ability to continue as a going concern, disclosing, as applicable, matters related to going concern in accordance with the latter part of Article 120-1 of the Ordinance of Companies Accounting that prescribes some omissions of disclosure items required by International Financial Reporting Standards.

Audit and supervisory board members and the audit and supervisory board are responsible for overseeing the directors' performance of their duties with regard to the design, implementation and maintenance of the Group's financial reporting process.



### Auditor's Responsibilities for the Audit of the Consolidated Financial Statements

Our objectives are to obtain reasonable assurance about whether the consolidated financial statements as a whole are free from material misstatement, whether due to fraud or error, and to issue an auditor's report that includes our opinion. Misstatements can arise from fraud or error and are considered material if, individually or in the aggregate, they could reasonably be expected to influence the economic decisions of users taken on the basis of these consolidated financial statements.

As part of our audit in accordance with auditing standards generally accepted in Japan, we exercise professional judgment and maintain professional skepticism throughout the audit. We also:

- Identify and assess the risks of material misstatement of the consolidated financial statements, whether due to fraud or error, design and perform audit procedures responsive to those risks, and obtain audit evidence that is sufficient and appropriate to provide a basis for our opinion.
- Obtain an understanding of internal control relevant to the audit in order to design audit procedures that are appropriate in the circumstances, while the objective of the audit is not to express an opinion on the effectiveness of the Group's internal control.
- Evaluate the appropriateness of accounting policies used and the reasonableness of accounting estimates and related disclosures made by management.
- Conclude on the appropriateness of management's use of the going concern basis of accounting and based on the audit evidence obtained, whether a material uncertainty exists related to events or conditions that may cast significant doubt on the Group's ability to continue as a going concern. If we conclude that a material uncertainty exists, we are required to draw attention in our auditor's report to the related disclosures in the consolidated financial statements or, if such disclosures are inadequate, to modify our opinion. Our conclusions are based on the audit evidence obtained up to the date of our auditor's report. However, future events or conditions may cause the Group to cease to continue as a going concern.
- Evaluate whether the presentation and disclosures in the consolidated financial statements are in accordance with the latter part of Article 120-1 of the Ordinance of Companies Accounting that prescribes some omissions of disclosure items required by International Financial Reporting Standards, the overall presentation, structure and content of the consolidated financial statements, including the disclosures, and whether the consolidated financial statements represent the underlying transactions and events in a manner that achieves fair presentation.
- Obtain sufficient appropriate audit evidence regarding the financial information of the entities or business activities within the Group to express an opinion on the consolidated financial statements. We are responsible for the direction, supervision and performance of the group audit. We remain solely responsible for our audit opinion.

We communicate with audit and supervisory board members and the audit and supervisory board regarding, among other matters, the planned scope and timing of the audit, significant audit findings, including any significant deficiencies in internal control that we identify during our audit.

We also provide audit and supervisory board members and the audit and supervisory board with a statement that we have complied with relevant ethical requirements regarding independence, and communicate with them all relationships and other matters that may reasonably be thought to bear on our independence, and where applicable, related safeguards.

### Interest required to be disclosed by the Certified Public Accountants Act of Japan

Our firm and its designated engagement partners do not have any interest in the Group which are required to be disclosed pursuant to the provisions of the Certified Public Accountants Act of Japan.

### Notes to the Readers of Independent Auditor's Report

This is an English translation of the Independent Auditor's Report as required by the Companies Act of Japan for the conveniences of the reader.

Yutaka Terasawa  
Designated Engagement Partner  
Certified Public Accountant

Kenji Tanaka  
Designated Engagement Partner  
Certified Public Accountant

Masashi Oki  
Designated Engagement Partner  
Certified Public Accountant

KPMG AZSA LLC  
Tokyo Office, Japan  
May 9, 2022

## Auditor's Report on Non-Consolidated Financial Statements

### Independent Auditor's Report

To the Board of Directors of Nippon Telegraph and Telephone Corporation:

#### **Opinion**

We have audited the financial statements, which comprise the non-consolidated balance sheet, the non-consolidated statement of income, the statement of changes in shareholders' equity and other net assets and the related notes to the non-consolidated financial statements, and the accompanying supplementary schedules ("the financial statements and the accompanying supplementary schedules") of Nippon Telegraph and Telephone Corporation ("the Company") as at March 31, 2022 and for the year from April 1, 2021 to March 31, 2022 in accordance with Article 436-2-1 of the Companies Act.

In our opinion, the financial statements and the accompanying supplementary schedules referred to above present fairly, in all material respects, the financial position and the results of operations of the Company for the period, for which the financial statements and the accompanying supplementary schedules were prepared, in accordance with accounting principles generally accepted in Japan.

#### **Basis for Opinion**

We conducted our audit in accordance with auditing standards generally accepted in Japan. Our responsibilities under those standards are further described in the *Auditor's Responsibilities for the Audit of the Financial Statements and the Accompanying Supplementary Schedules* section of our report. We are independent of the Company in accordance with the ethical requirements that are relevant to our audit of the financial statements in Japan, and we have fulfilled our other ethical responsibilities in accordance with these requirements. We believe that the audit evidence we have obtained is sufficient and appropriate to provide a basis for our opinion.

#### **Emphasis of Matter**

We draw attention to Note "Realignment of the Global Business" under "Subsequent Events" in the related notes to the non-consolidated financial statements. The Company has resolved at the Board of Directors meeting held on May 9, 2022, that it will realign NTT group's global business (the "Realignment") by grouping the global businesses operated under NTT, Inc. and NTT Lmt. with the global business operated by NTT DATA Corporation ("NTT DATA") group, and has executed with NTT DATA a master agreement regarding the Realignment and shareholders' agreement. Based upon the resolution at the Board of Directors meeting held on May 9, 2022, the Company will acquire shares of NTT DATA up to 60 million shares or 100 billion yen through market transactions. Our opinion is not modified in respect of this matter.

#### **Other Information**

The other information comprises the business report and its supplementary schedules. Management is responsible for the preparation and presentation of the other information. Audit and supervisory board members and the audit and supervisory board are responsible for overseeing the directors' performance of their duties with regard to the design, implementation and maintenance of the reporting process for the other information.

Our opinion on the financial statements and the accompanying supplementary schedules does not cover the other information and we do not express any form of assurance conclusion thereon.

In connection with our audit of the financial statements and the accompanying supplementary schedules, our responsibility is to read the other information and, in doing so, consider whether the other information is materially inconsistent with the financial statements and the accompanying supplementary schedules or our knowledge obtained in the audit, or otherwise appears to be materially misstated.

If, based on the work we have performed, we conclude that there is a material misstatement of this other information, we are required to report that fact.

We have nothing to report in this regard.

#### **Responsibilities of Management and Audit and Supervisory Board Members and Audit and Supervisory Board for the Financial Statements and the Accompanying Supplementary Schedules**

Management is responsible for the preparation and fair presentation of the financial statements and the accompanying supplementary schedules in accordance with accounting principles generally accepted in Japan, and for such internal control as management determines is necessary to enable the preparation of financial statements and the accompanying supplementary schedules that are free from material misstatement, whether due to fraud or error.

In preparing the financial statements and the accompanying supplementary schedules, management is responsible for assessing the Company's ability to continue as a going concern, disclosing, as applicable, matters related to going concern in accordance with accounting principles generally accepted in Japan.

Audit and supervisory board members and the audit and supervisory board are responsible for overseeing the directors' performance of their duties with regard to the design, implementation and maintenance of the Company's financial reporting process.

### Auditor's Responsibilities for the Audit of the Financial Statements and the Accompanying Supplementary Schedules

Our objectives are to obtain reasonable assurance about whether the financial statements and the accompanying supplementary schedules as a whole are free from material misstatement, whether due to fraud or error, and to issue an auditor's report that includes our opinion. Misstatements can arise from fraud or error and are considered material if, individually or in the aggregate, they could reasonably be expected to influence the economic decisions of users taken on the basis of these financial statements and the accompanying supplementary schedules.

As part of our audit in accordance with auditing standards generally accepted in Japan, we exercise professional judgment and maintain professional skepticism throughout the audit. We also:

- Identify and assess the risks of material misstatement of the financial statements and the accompanying supplementary schedules, whether due to fraud or error, design and perform audit procedures responsive to those risks, and obtain audit evidence that is sufficient and appropriate to provide a basis for our opinion.
- Obtain an understanding of internal control relevant to the audit in order to design audit procedures that are appropriate in the circumstances, while the objective of the audit is not to express an opinion on the effectiveness of the Company's internal control.
- Evaluate the appropriateness of accounting policies used and the reasonableness of accounting estimates and related disclosures made by management.
- Conclude on the appropriateness of management's use of the going concern basis of accounting and based on the audit evidence obtained, whether a material uncertainty exists related to events or conditions that may cast significant doubt on the Company's ability to continue as a going concern. If we conclude that a material uncertainty exists, we are required to draw attention in our auditor's report to the related disclosures in the financial statements and the accompanying supplementary schedules or, if such disclosures are inadequate, to modify our opinion. Our conclusions are based on the audit evidence obtained up to the date of our auditor's report. However, future events or conditions may cause the Company to cease to continue as a going concern.
- Evaluate whether the presentation and disclosures in the financial statements and the accompanying supplementary schedules are in accordance with accounting standards generally accepted in Japan, the overall presentation, structure and content of the financial statements and the accompanying supplementary schedules, including the disclosures, and whether the financial statements and the accompanying supplementary schedules represent the underlying transactions and events in a manner that achieves fair presentation.

We communicate with audit and supervisory board members and the audit and supervisory board regarding, among other matters, the planned scope and timing of the audit, significant audit findings, including any significant deficiencies in internal control that we identify during our audit.

We also provide audit and supervisory board members and the audit and supervisory board with a statement that we have complied with relevant ethical requirements regarding independence, and communicate with them all relationships and other matters that may reasonably be thought to bear on our independence, and where applicable, related safeguards.

### Interest required to be disclosed by the Certified Public Accountants Act of Japan

Our firm and its designated engagement partners do not have any interest in the Company which are required to be disclosed pursuant to the provisions of the Certified Public Accountants Act of Japan.

### Notes to the Readers of Independent Auditor's Report

This is an English translation of the Independent Auditor's Report as required by the Companies Act of Japan for the conveniences of the reader.

Yutaka Terasawa  
Designated Engagement Partner  
Certified Public Accountant

Kenji Tanaka  
Designated Engagement Partner  
Certified Public Accountant

Masashi Oki  
Designated Engagement Partner  
Certified Public Accountant

KPMG AZSA LLC  
Tokyo Office, Japan  
May 9, 2022

## Audit & Supervisory Board's Report

### AUDIT & SUPERVISORY BOARD'S REPORT

Based on reports from each Audit & Supervisory Board Member, and following due discussion at meetings, the Audit & Supervisory Board has prepared this report regarding the execution of the duties of the Members of the Board in the 37th fiscal year from April 1, 2021 to March 31, 2022. The Board reports as follows:

#### 1. Outline of Audit Methodology

- (1) The Audit & Supervisory Board established auditing policies and received reports from each Audit & Supervisory Board Member on the status of the implementation of audits and the results thereof, as well as reports regarding the status of execution of duties from the Members of the Board and other persons and the Independent Auditors, and requested explanations as necessary.
- (2) On the basis of the Audit & Supervisory Board Rules, and in accordance with its auditing policies, the Audit & Supervisory Board Members sought mutual understanding with Members of the Board, the internal auditing department and employees and other persons in their efforts to collect information and achieve an environment conducive to audits, and conducted the audits based on the methods described below.
  - I. The Audit & Supervisory Board Members attended meetings of the Board of Directors and other important meetings, and received reports from Members of the Board, employees and other persons regarding performance of their duties, requested explanations as necessary, perused important statements regarding decisions and approvals made and investigated the status of operations and assets at the head office and R&D laboratories. Regarding the subsidiaries, the Audit & Supervisory Board sought to achieve a mutual understanding and exchange of information with Members of the Board and Audit & Supervisory Board Members and other persons of the subsidiaries, and where necessary received business reports from the subsidiaries.
  - II. With respect to the particulars of Board of Directors resolutions relating to establishment of structures as set forth in Article 100 (1) and (3) of the Ordinance for Enforcement of the Companies Act, necessary to ensure that Board Members' performance of their duties, as stated in the Business Report, is in conformity with laws and regulations and their company's Articles of Incorporation and to otherwise ensure the appropriateness of the business of a corporate group consisting of a kabushiki kaisha and its subsidiaries, as well as the structures established pursuant to such resolutions (internal control systems), the Audit & Supervisory Board Members received reports regularly from Members of the Board and other employees regarding the status of the establishment and implementation of the systems, requested explanations as necessary, and expressed opinions thereon.
  - III. The Audit & Supervisory Board Members audited and verified whether the Independent Auditor maintained its independence and carried out its audits appropriately, received reports from the Independent Auditor regarding the execution of its duties and, where necessary, requested explanations. Also, the Audit & Supervisory Board received notification from the Independent Auditors to the effect that the "structure to ensure that duties are

executed appropriately" (the matters listed in Article 131 of the Regulation on Corporate Accounting) has been established in accordance with "Quality Control Standards for Auditing" (Business Accounting Council, October 28, 2005) and, where necessary, requested explanations.

Based on the above methodology, the Audit & Supervisory Board audited the Business Report and related supplementary schedules, the non-consolidated financial statements (non-consolidated balance sheet, non-consolidated statement of income, non-consolidated statement of changes in shareholders' equity and other net assets, notes to non-consolidated financial statements) and related supplementary schedules, as well as the consolidated financial statements (consolidated statement of financial position, consolidated statement of profit or loss, consolidated statement of changes in equity and notes to consolidated financial statements) related to the fiscal year under review.

#### 2. Audit Results

- (1) Results of the audit of the Business Report
  - I. We find that the Business Report and its supplementary schedules accurately reflect the conditions of the company in accordance with applicable laws and the Articles of Incorporation.
  - II. No inappropriate conduct concerning the execution of duties by Members of the Board or material facts in violation of law or the Articles of Incorporation were found.
  - III. We find that the particulars of Board of Directors' resolutions concerning the internal control systems are appropriate.  
Further, no matters worthy of note were found with respect to the content of the Business Report and Board Members' execution of duties in regards to the internal control systems.
- (2) Results of the audit of the non-consolidated financial statements and supplementary schedules  
We find that the methodology and results of the audit by the Independent Auditor, KPMG AZSA LLC, are appropriate.
- (3) Results of the audit of the consolidated financial statements  
We find that the methodology and results of the audits conducted by the Independent Auditor, KPMG AZSA LLC, are appropriate.

May 10, 2022

Nippon Telegraph and Telephone Corporation  
Audit & Supervisory Board

Full-time Audit & Supervisory Board Member	Takao Maezawa
Full-time Audit & Supervisory Board Member	Kanae Takahashi
Audit & Supervisory Board Member	Takashi Iida
Audit & Supervisory Board Member	Hideki Kanda
Audit & Supervisory Board Member	Kaoru Kashima

Notes: 1. Audit & Supervisory Board Members Takashi Iida, Hideki Kanda, Kaoru Kashima are outside Audit & Supervisory Board Members as prescribed in Article 2(xvi), and Article 335(3) of the Companies Act.

2. The Audit & Supervisory Board Members have provided their seal by electronic means.

END

(Reference) **Glossary of Terms****General Terms****▼ B2B2X**

An initiative aimed at working together with service providers such as local government bodies or business operators in other fields (B) to provide solutions to social problems and new value creation for end users (X) through working behind the scene or in intermediary roles to expand cooperation with the aforementioned service providers and conducting activities that support digital transformation.

**▼ CSV**

Creating Shared Value. A management framework that seeks to achieve both social value and corporate value arising from the solution of social issues through a company's business.

**▼ Digital Transformation (DX)**

Process of creating new business models or transforming existing business by using ICT tools to accumulate various data or use data in management.

**▼ ESG**

An acronym for Environment, Social, and Governance. A benchmark for evaluating the sustainability of company management.

**▼ Managed Services**

A service for undertaking installation, management, operation, and maintenance of the equipment and software needed for use of telecommunication services, IT services, and others.

**▼ SDGs**

Sustainable Development Goals. International goals adopted at the United Nations Summit for achieving a sustainable and better world by 2030.

**▼ Smart City**

A city that realizes improved convenience and comfort of daily life, and solutions to various issues, through more efficient and advanced urban and regional functions and services by the use of advanced technologies.

**▼ Zero Trust**

A security approach predicated on external and cloud access, in which safety confirmations are performed every time access is initiated

**Terms Related to NTT Group Services****▼ d POINT**

Reward points that can be accumulated and used in various ways, including through monthly DOCOMO mobile phone charges and shopping in real and online stores. Accumulated points can be used for shopping at the rate of 1 point = 1 yen.

**▼ docomo Hikari**

An optical Internet service provided by NTT DOCOMO using a FLET'S Hikari line or cable TV equipment.

**▼ FLET'S Hikari**

A collective name for fiber optic Internet connection services provided by NTT East and NTT West.

**▼ Hikari Collaboration Model**

The wholesale provision of FLET'S Hikari and other services provided by NTT East and NTT West to various service providers.

**(Regarding the Contents of the Business Report)**

- In this Business Report, "NTT DOCOMO," "NTT Communications," "NTT Comware," "NTT East," "NTT West," and "NTT DATA" refer to NTT DOCOMO, INC., NTT Communications Corporation, NTT COMWARE CORPORATION, Nippon Telegraph and Telephone East Corporation, Nippon Telegraph and Telephone West Corporation, and NTT DATA Corporation respectively.
- The consolidated financial statements of NTT have been prepared in accordance with International Financial Reporting Standards (IFRS).
- With respect to amounts appearing in this Business Report, figures are rounded to the nearest whole unit.
- With respect to underlined terms, a definition of each term is provided in the "Glossary of Terms."
- The forward-looking statements, remarks and projected figures concerning the future performance of NTT and its subsidiaries and affiliates contained or referred to herein are based on a series of assumptions, projections, estimates, judgments and beliefs of the management of NTT in light of information currently available to it regarding NTT and its subsidiaries and affiliates, the economy and telecommunications industry in Japan and overseas, and other factors. These projections and estimates may be affected by the future business operations of NTT and its subsidiaries and affiliates, the state of the economy in Japan and abroad, possible fluctuations in the securities markets, the pricing of services, the effects of competition, the performance of new products, services and new businesses, changes to laws and regulations affecting the telecommunications industry in Japan and elsewhere, other changes in circumstances that could cause actual results to differ materially from the forecasts contained or referred to herein, as well as other risks included in this Business Report.

## Real-time Streaming over the Internet on the Day of the General Meeting of Shareholders

Date and time of streamed broadcast  
**Friday, June 24, 2022,  
beginning at 10:00 a.m. (JST)**

The Company strongly requests that you refrain from attending the meeting as you will be able to view the state of affairs on the day through a real-time stream over the Internet.

**For URL, please refer to the Notice of Convocation scheduled to be sent on June 2, 2022.**

\* While viewing, shareholders will be unable to exercise their voting rights or ask questions. To prevent the spread of the COVID-19, please exercise your voting rights and send your questions over the Internet, etc. prior to the meeting.

## Reception of Questions over the Internet Prior to the Meeting

Deadline:  
**5:30 p.m., Thursday, June 23, 2022 (JST)**

The Company will receive questions from shareholders regarding matters to be reported and matters to be resolved in relation to the 37th Ordinary General Meeting of Shareholders prior to the meeting.

Following the procedures below, please input the required items on the reception form and send it by the deadline.

**For URL, please refer to the Notice of Convocation scheduled to be sent on June 2, 2022.**

1

Access the Company's website above from any one of PCs, smartphones, etc.



2

Input required items, such as name and shareholder number, on the reception form.



3

Click the send button after confirming the details input.

\* The Company plans to post the answers to the questions received on its website. Furthermore, the Company plans to introduce a portion of these questions at the meeting.

\* Questions that are not related to matters to be reported or matters to be resolved at the meeting may not be answered.

\* Questions may also be received in writing. Please send your question to the address below by mail so that it arrives before the deadline.

[Address] IR Office, NIPPON TELEGRAPH AND TELEPHONE CORPORATION 5-1, Otemachi 1-chome, Chiyoda-ku, Tokyo 100-8116